

Nomenclature of Organic Chemistry. IUPAC Recommendations and Preferred Names 2013.

Prepared for publication by Henri A. Favre and Warren H. Powell,
Royal Society of Chemistry, ISBN 978-0-85404-182-4

Chapter P-9 SPECIFICATION OF CONFIGURATION AND CONFORMATION

- P-90 Introduction
- P-91 Stereoisomer graphical representation and naming
- P-92 The Cahn-Ingold-Prelog (CIP) priority system and the Sequence Rules
- P-93 Configuration specification
- P-94 Conformation and conformational stereodescriptors

P-90 INTRODUCTION

This Chapter is concerned only with the main principles for specification of configuration and conformation of organic compounds. The structure of an organic compound is systematically indicated by one or more affixes added to a name that does not itself prescribe stereochemical configuration or conformation; such affixes are generally called 'stereodescriptors'. Thus, stereoisomers, such as enantiomers, have names that differ only in the stereodescriptors used. In contrast, '*cis/trans*' isomers may have different names because of different stereodescriptors or names differing in the type of nomenclature. Also, certain retained names imply their own stereochemical description, for example, maleic acid, cholesterol, and other natural products described in Chapter P-10.

In order to arrive at an unambiguous description of stereoisomers, Cahn, Ingold, and Prelog (refs. 34, 35) recommended an order of seniority for the ligands (atoms and groups) attached to carbon and other atoms, which is commonly called the 'CIP priority system'. The priority is established by the application of 'Sequence Rules'. These rules are discussed in P-92. Their application is then described for stereogenic units, mainly for the most usual compounds encountered in organic chemistry. Synthetic compounds are discussed in P-93 and Natural Products in Chapter P-10.

When different stereodescriptors are recommended to describe *cis* and *trans* isomers, diastereoisomers, and enantiomers, one of them is recommended as a preferred stereodescriptor. This preferred stereodescriptor is used to generate a preferred IUPAC name. Obviously, in general nomenclature, any appropriate descriptor can be used.

Example:

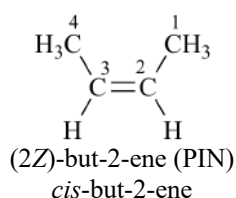

P-91 STEREOISOMER GRAPHICAL REPRESENTATION AND NAMING

- P-91.1 Stereoisomer graphical representation
- P-91.2 Stereodescriptors
- P-91.3 Naming of stereoisomers

P-91.1 STEREOISOMER GRAPHICAL REPRESENTATION

Structural diagrams which depict configurations must be prepared with extra care. Recommendations were made in 1996 to achieve that goal (ref. 37). A new set of recommendations is now proposed in the document entitled 'Graphical representation of stereochemical configuration, IUPAC Recommendations 2006' (ref. 38).

In general, plain lines depict bonds approximately in the plane of the drawing. Bonds to atoms above the plane are shown by a solid wedge (starting from an atom in the plane of the drawing at the narrow end of the wedge); bonds to atoms below the plane are shown by a hashed wedge interpreted in a sense similar to the solid wedge (starting from an atom in the plane of the drawing at the narrow end of the wedge). If the configuration is unknown, this can be indicated explicitly by a wavy line of constant amplitude . These bonds are used in this book, with exceptions in the field of natural products clearly indicated in Chapter P-10 for carbohydrates.

In this Chapter, a single graphical representation depicts the absolute configuration of a chiral molecule.

P-91.2 STERODESCRIPTOR

The configuration of an organic compound is systematically indicated by one or more affixes added to a name that does not itself prescribe configuration; such affixes are called 'stereodescriptors'.

P-91.2.1 Recommended stereodescriptors

P-91.2.2 Omission of stereodescriptors

P-91.2.1 Recommended stereodescriptors

Stereodescriptors are divided into two types:

P-91.2.1.1 Cahn-Ingold-Prelog (CIP) stereodescriptors

P-91.2.1.2 Other acceptable stereodescriptors

P-91.2.1.1 Cahn-Ingold-Prelog (CIP) stereodescriptors

Some stereodescriptors described in the Cahn-Ingold-Prelog (CIP) priority system, called 'CIP stereodescriptors', are recommended to specify the configuration of organic compounds, as described and exemplified in this Chapter and applied in Chapters P-1 through P-8, and in the nomenclature of natural products in Chapter P-10. The following stereodescriptors are used as preferred stereodescriptors (see P-92.1.2):

- (a) '*R*' and '*S*', to designate the absolute configuration of tetracoordinate (quadriligant) chirality centers;
- (b) '*r*' and '*s*', to designate the absolute configuration of pseudoasymmetric centers;
- (c) '*M*' and '*P*', to specify the absolute configuration of an axial or planar entity using the helicity rule;
- (d) '*m*' and '*p*', to specify the absolute configuration of a pseudoasymmetric entity using the helicity rule;
- (e) '*seqCis*' and '*seqTrans*', to describe the configuration of enantiomorphic double bonds;

To specify the relative configuration the descriptor '*rel*' associated with '*R*' or '*S*' is preferred to the stereodescriptors '*R**' or '*S**'. Racemates are described by the descriptor '*rac*' which is preferred to '*RS*' or '*SR*' stereodescriptors.

The following stereodescriptors are recommended for general nomenclature:

'*R_a*' and '*S_a*' to specify the configuration of molecular entities possessing axial chirality;

'*R_p*' and '*S_p*', to specify the configuration of molecular entities possessing planar chirality;

'*r_a*' and '*s_a*', to specify the configuration of pseudoasymmetric stereogenic axes;

'*r_p*' and '*s_p*', to specify the configuration of pseudoasymmetric stereogenic planes.

Capitalized CIP stereodescriptors are variant on reflection in a mirror (i.e. '*R*' becomes '*S*' and '*S*' becomes '*R*'); lower-case CIP stereodescriptors are invariant on reflection in a mirror (i.e. '*r*' remains '*r*' and '*s*' remains '*s*'). They are written in italics to indicate that they are not involved in the primary stage of alphanumerical order (see P-16.6).

P-91.2.1.2 Other acceptable stereodescriptors

Non Cahn-Ingold-Prelog (CIP) stereodescriptors are divided into two categories:

P-91.2.1.2.1 Stereodescriptors used in substitutive nomenclature;

P-91.2.1.2.2 Stereodescriptors used in the nomenclature of natural products (see Chapter P-10).

P-91.2.1.2.1 Stereodescriptors used in substitutive nomenclature

Stereodescriptors used in systematic substitutive names to specify the configuration of preferred IUPAC names and in general nomenclature; some stereodescriptors are recommended in general nomenclature only:

(a) Stereodescriptors used in preferred IUPAC names

- (i) '*E*' and '*Z*' to describe the configuration of diastereomorphic alkenes $R^1R^2C=CR^3R^4$ ($R^1 \neq R^2$, $R^3 \neq R^4$ and neither R^1 nor R^2 need be different from R^3 or R^4), cumulenes $R^1R^2C=[C=]_nCR^3R^4$, systems for example, $R^1R^2C=NOH$ and $HON=C\{[CH_2]_n\}_2C=NOH$. The group of highest CIP priority attached to one of the terminal doubly bonded atoms of the alkene, oxime, etc., or cumulene (i.e. R^1 or R^2) is compared with the group of highest precedence attached to the other (i.e. R^3 or R^4). The stereoisomer is designated as '*Z*' (zusammen = together) if the groups lie on the same side of a reference plane passing through the double bond and perpendicular to the plane containing the bonds linking the groups to the double bond atoms; the other isomer is designated '*E*' (entgegen = opposite). The descriptors may be applied to structures with a fractional bond order between one or two; and to double bonds involving elements other than carbon.

(ii) 'A' and 'C' to describe the absolute configuration of pentacoordinate (pentaligant, as in a trigonal bipyramid or square pyramid) and hexacoordinate (hexaligant, as in an octahedron) stereogenic centers.

(b) The following stereodescriptors are recommended for general nomenclature:

(i) 'cis', 'trans' and 'r', 'c', 't' are used to specify the configuration of diastereomorphic double bonds (see P-93.4.2.1.1) and the relative configuration of alicyclic compounds (see P-93.5.1.3), respectively;

(ii) 'endo', 'exo', 'syn', and 'anti' are used to specify the relative configuration of some von Baeyer ring systems (see P-93.5.2.2.1).

In preferred IUPAC names, stereodescriptors, preceded by a locant, **must be** cited to specify each stereogenic unit, as illustrated in P-91.3. When the configuration is not known or must remain unspecified for lack of configurational homogeneity, the italicized symbol 'ξ' or 'Ξ' is used, preceded by the required locant (see P-91.3). The symbol 'ξ' (small Greek letter 'xi') replaces noncapitalized CIP stereodescriptors such as 'r', 's', 'm', 'p'. The symbol 'Ξ' (capital Greek letter 'xi') replaces capitalized CIP stereodescriptors such as 'R', 'S', 'M', 'P', 'E', 'Z', 'seqCis', and 'seqTrans'.

P-91.2.1.2.2 Stereodescriptors used in the nomenclature of natural products (see Chapter P-10):

(i) The descriptors 'D' and 'L' are used to describe the configuration of carbohydrates (ref. 27 and P-102), amino acids and peptides (ref. 18 and P-103), and cyclitols (ref. 39 and P-104);

(ii) The descriptors 'erythro' and 'threo' are used in the systematic nomenclature of carbohydrates, along with descriptors such as 'arabino' and 'gluco' (see ref. 27 and P-102);

(iii) The stereodescriptors 'α', 'β' are used in the nomenclature of natural products to describe the absolute configuration of alkaloids, terpenes and terpenoids, steroids, and other compounds as described in P-101;

(iv) The stereodescriptors 'cis', 'trans' and 'all-E' and 'all-trans' are used in the nomenclature of carotenoids and similar compounds (see ref. 40 and P-101.6);

(v) The descriptor 'meso' is used in the nomenclature of carbohydrates to designate compounds such as alditols and aldaric acids that are symmetrical and thus optically inactive (see P-102.5.6.5.2; P-102.5.6.6.5);

(vi) The stereodescriptor 'ambo' describes the formation of diastereoisomers by reaction at a nonstereogenic center of a chiral molecule or the reaction of a chiral compound with a racemic compound which will not normally give a 50:50 mixture. To indicate this, the prefix 'ambo' is used (see P-93.1.4 and P-103.3.4)

P-91.2.2 Omission of stereodescriptors

The omission of stereodescriptors specifying double bonds is recommended in the case of three- through seven-membered unsaturated alicyclic compounds where any double bond has a fixed configuration, 'Z' in the case of hydrocarbons, and 'Z' or 'E' in accordance with the nature of ligands attached to the double bond (see P-93.5.1.4.1). Names such as 'cyclohexene' or 'cyclohepta-1,3,5-triene' are unambiguous; the addition of the stereodescriptor 'Z' would add no further information. In eight-membered rings, the stereodescriptor 'Z' or 'E', with its locant, is required: in preferred IUPAC names when one double bond is present, i.e. in '(Z)-cyclooctene' and '(E)-cyclooctene', but not in the corresponding di-, tri-, or tetraene, i.e. 'cycloocta-1,3,5,7-tetraene'. From nine-membered rings onwards, stereodescriptors are required. The omission of stereodescriptors is also recommended in names of von Baeyer systems (P-93.5.2.3), spiro compounds (P-93.5.3.3), fused systems (P-93.5.4), cyclophane systems (P-93.5.5.3), and assemblies of identical rings and ring systems (P-93.5.7.3).

P-91.3 NAMING OF STEREOISOMERS

Stereodescriptors are added to a name constructed in accordance with the procedure of formation of preferred IUPAC names described in P-59.1. The rule expressed in Rule E-0 (ref. 1) and in R-7.0 (ref. 2) that 'stereodescriptors do not change the name or the numbering of a compound established by the principles, rules and conventions of nomenclature described in these recommendations' is still valid, especially for preferred IUPAC names. Nesting symbols may change the nesting pattern established before the introduction of these affixes. This issue is discussed and illustrated in P-16.5.4.1 and P-93.6.

In preferred IUPAC names, stereodescriptors are placed immediately at the front of the part of the name to which they relate. They are placed at the front of the complete name when related to the parent structure; they are cited in parentheses followed by a hyphen. When they relate to substituent groups, they are cited at the front of the corresponding prefix. They are preceded by a numerical or letter locant to describe the position of the stereogenic unit when such locants are present; general rules of numbering are applied (see P-14.4).

Examples:

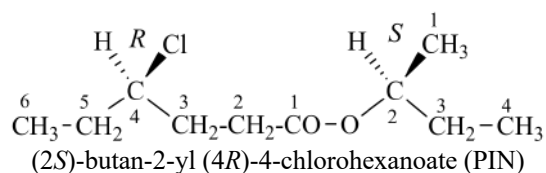
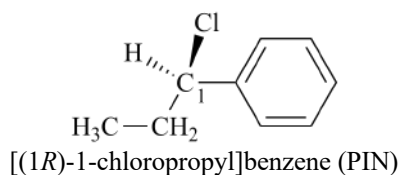
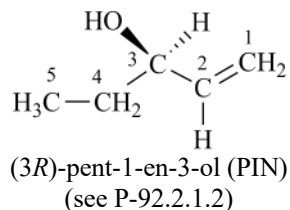
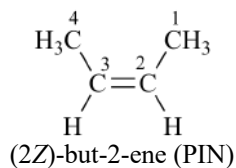
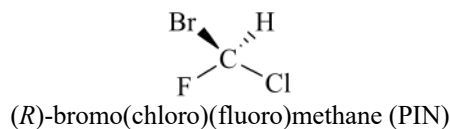

When a molecule contains more than one stereogenic unit, the above mentioned procedure is applied to each stereogenic unit, and the configuration of the parent structure is expressed as a set of symbols. In names of compounds, the symbols, with their locants, are written in parentheses and separated by a comma, followed by a hyphen, at the front of the complete name or substituent. Multiple stereodescriptors are cited in the increasing order of their respective locants.

Examples:

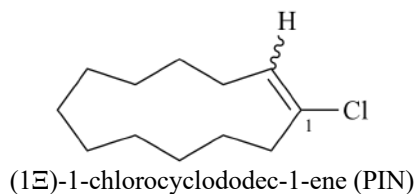
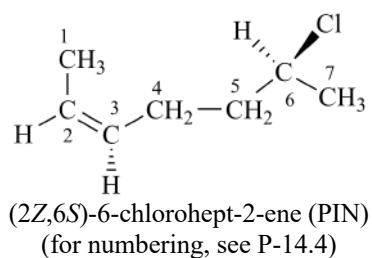
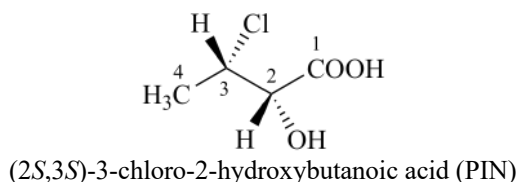

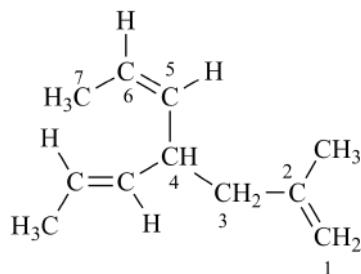

(*SZ*)-4-[(*1E*)-prop-1-en-1-yl]hepta-1,5-diene (PIN)

Note: In illustrating just the double bonds, the stereodescriptor of the chirality center at 'C-4' is not included in the name.

P-92 THE CAHN-INGOLD-PRELOG (CIP) PRIORITY SYSTEM AND THE SEQUENCE RULES

P-92.1 The Cahn-Ingold-Prelog (CIP) System: General methodology

P-92.2 Sequence Rule 1

P-92.3 Sequence Rule 2

P-92.4 Sequence Rule 3

P-92.5 Sequence Rule 4

P-92.6 Sequence Rule 5

P-92.1 THE CAHN-INGOLD-PRELOG (CIP) SYSTEM: GENERAL METHODOLOGY

P-92.1.1 Stereogenic units

P-92.1.2 Rules for the assignment of configuration

P-92.1.3 The Sequence Rules

P-92.1.4 Hierarchical digraphs

P-92.1.5 Exploration of a hierarchical digraph

P-92.1.6 Ligand ranking: application of the five Sequence Rules

P-92.1.1 Stereogenic units

A stereogenic unit (i.e. a unit generating stereoisomerism) is a grouping within a molecular entity that may be considered to generate stereoisomerism. At least one stereogenic unit must be present in every chiral molecule; however, conversely, the presence of stereogenic units does not require the corresponding molecular entity to be chiral. In preferred IUPAC names, all stereogenic units must be specified, unless an omission is allowed according to P-91.2.2.

Chirality is the property of an object, thus of a molecular entity, of being nonsuperposable on its mirror image. If the object (molecular entity) is superposable on its mirror image, it is said to be 'achiral'. Usual configurational terms used in this Chapter are defined in ref. 37.

The basic types of stereogenic units in molecular entities involving atoms having not more than four ligands are considered below:

(a) A chirality center. A grouping of atoms consisting of a central atom 'X' and distinguishable ligands 'a', 'b', 'c', 'd', so that the interchange of any two of the ligands 'a', 'b', 'c', or 'd' leads to a stereoisomer (see also P-93.5.3.2).

Example:

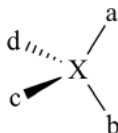

A chirality center denoted by '*R*' for the sequence 'a > b > c > d'

(b) A chirality axis. An axis about which a set of ligands is held so that it results in a spatial arrangement which is not superposable on its mirror image. For example, with an allene, 'abC=C=Cmn', the chirality axis is defined by the 'C=C=C' bonds; and with an *ortho*-substituted 1,1'-biphenyl the atoms 'C-1', 'C-1'', 'C-4', and 'C-4'' lie on the chirality axis (see ref. 37).

Example:

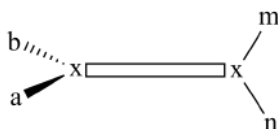

A chirality axis denoted by '*M*' for the sequence 'a > b' and 'm > n'

(c) A chirality plane. A planar unit 'a-x-b' connected to an adjacent part of the structure by an out-of-plane bond 'y-z' which results in restricted torsion so that the plane cannot lie in a symmetry plane.

Example:

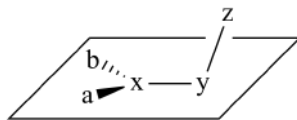

A chirality plane denoted by 'M' for 'a > b'

(d) Stereogenic units are called pseudoasymmetric (center, axis or plane) when they have distinguishable ligands 'a', 'b', 'c', 'd', two and only two of which are nonsuperposable mirror images of each other (enantiomorphic). These enantiomorphic ligands are represented by 'F' and 'f' as designated by Prelog and Helmchen (see ref. 36). The 'r/s' and 'm/p' stereodescriptors describing a pseudoasymmetric stereogenic unit are invariant on reflection in a mirror (for example 'r' remains 'r', and 's' remains 's'), but are reversed by the exchange of any two ligands ('r' becomes 's', and 's' becomes 'r'). Lower case stereodescriptors are used to describe pseudoasymmetric stereogenic units.

Examples:

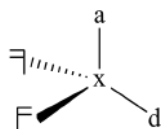

A pseudoasymmetric stereogenic unit denoted by 'r' for 'a > F > f > d'
('F' and 'f' are enantiomorphic ligands)

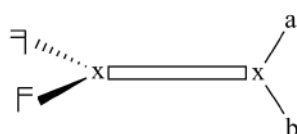

A pseudoasymmetric stereogenic unit denoted by 'm' for 'a > b and F > f'
('F' and 'f' are enantiomorphic ligands)

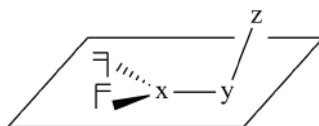

A pseudoasymmetric stereogenic unit denoted by 'm' for 'F > f'
('F' and 'f' are enantiomorphic ligands)

(e) *cis/trans* Isomers containing a double bond. A grouping of atoms consisting of a double bond with different ligands which give rise to *cis-trans* isomerism.

Example:

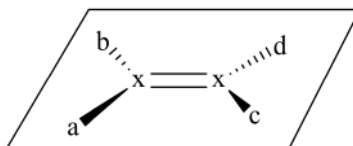

A double bond denoted as 'E' for 'a > b' and 'd > c'

(f) An enantiomorphic double bond

Example:

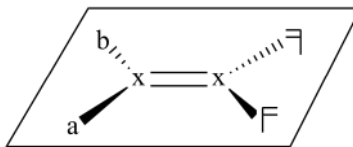

An enantiomorphic double bond denoted *seqCis* for 'a > b' and 'F > f'
('F' and 'f' are enantiomorphic ligands)

P-92.1.2 Rules for the assignment of configuration

This section describes the CIP priority system which was developed to deal with all compounds with a bonding number up to six for organic compounds, and for all configurations and conformations of these compounds (refs. 34, 35, 36). Its description for specifying configurations and conformations is discussed herein.

P-92.1.2.1 The chirality rule and the stereodescriptors 'R', 'S', 'R_a', 'S_a', 'R_p', 'S_p'

For a tetrahedral stereogenic unit having four different ligands, the chirality rule is based on the arrangement of these ligands (including chains and rings) in an order of precedence, often referred to as an order of priority. For discussion this order can conveniently be generalized as 'a > b > c > d', where '>' means 'has priority over' or 'has precedence

over'. The order of precedence is reached by the construction of a hierarchical digraph and the application of the Sequence Rules as explained below.

The chirality rule is expressed by Prelog and Helmchen (see subsection 5.1, ref. 36) as follows: "Among ligands of highest precedence the path of their sequence is followed from the preferred side of the model, that is, the side remote from the group of lowest precedence, and, depending on whether the path turns to right or left, the chirality unit will be assigned the chiral label 'R' or 'S', or, if pseudoasymmetric, 'r' or 's'".

This rule is applied to stereogenic centers, stereogenic axes, and stereogenic planes.

P-92.1.2.1.1 Stereogenic centers

For 'a > b > c > d', two enantiomeric stereogenic centers are described as 'R' or 'S' depending of the sense of chirality as shown below.

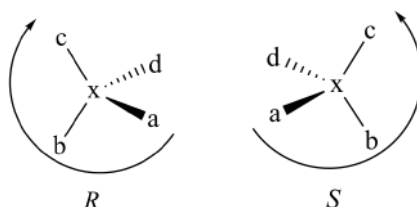

P-92.1.2.1.2 Stereogenic axes

Structures with axial chirality are regarded as elongated tetrahedra and viewed along the axis; it is immaterial from which side they are viewed (see subsection 2.5.2, ref. 36). Axial chirality is used to refer to stereoisomerism resulting from the nonplanar arrangement of four groups in pairs about a chirality axis. A chirality axis is the axis about which a set of atoms or groups is held so that a spatial arrangement results which is not superposable on its mirror image. For instance, in an allene 'abC=C=Ccd', the chirality axis is defined by the 'C=C=C' bonds, and in a '2,2',6,6'-tetrasubstituted 1,1'-biphenyl the atoms '1,1',4,4'' lie on the chirality axis.

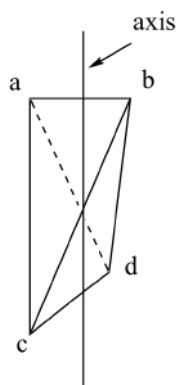

In chiral compounds owing their chirality to a stereogenic center, it is necessary to have four different atoms or groups 'a', 'b', 'c', and 'd'. With an elongated tetrahedron, this requirement is no longer necessary because of reduced symmetry. The only condition is that 'a' be different from 'b', and 'c' be different from 'd'; thus compounds with two pairs of ligands 'a' and 'b' are chiral if 'a' is different than 'b'.

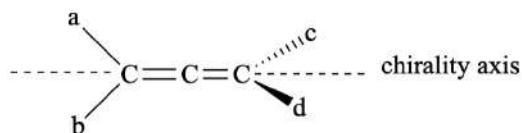

The configuration is specified by the descriptors 'R_a' and 'S_a' assigned as follows:

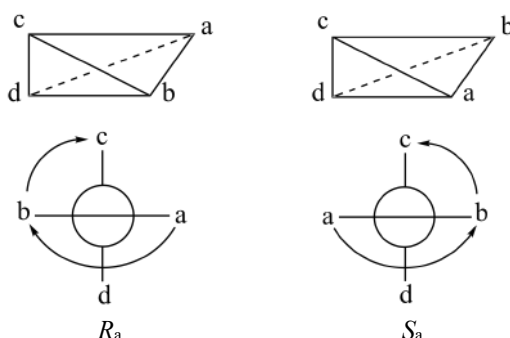

Ligands (atoms or groups) are arranged in the elongated tetrahedral system. Two higher-ranking substituents are chosen, one in each pair, using the Sequence Rule. For the pairs 'a > b' and 'c > d', the chirality is described by the symbol '*R_a*' if the path going from 'a to b to c' is clockwise, while looking toward 'd'. The chirality symbol is '*S_a*' if this path is anticlockwise.

P-92.1.2.1.3 Stereogenic planes

Planar chirality is a term used to refer to stereoisomerism resulting from the arrangement of out of plane groups with respect to a plane (stereogenic plane) (see 2.5.2, ref. 36). It is exemplified by the atropisomerism of a monosubstituted cyclophane in which the stereogenic plane is the substituted 'phane amplificant' (see P-26). The configuration is specified by the stereodescriptors '*R_p*' and '*S_p*' assigned as follows:

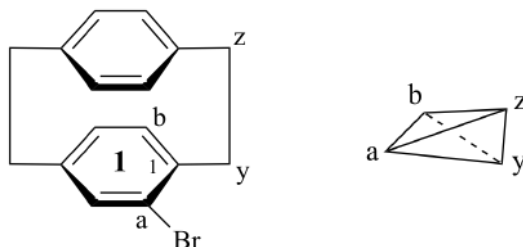

A tetrahedron (tetrahedral stereogenic unit) is derived by connecting the in-plane reference atoms 'a' and 'b' to the atoms 'y' and 'z'. The chirality sense is determined by conventional rules establishing the priority order 'a > b > c > d' or 'a > b > y > z' for the cyclophane above. Thus, the descriptor '*S_p*' is used to denote the configuration and assigned to the carbon atom 'C-1¹'.

P-92.1.2.2 The helicity rule: stereodescriptors '*M*' and '*P*'

Helicity is the chiral sense of a helical, propeller, or screw-shaped molecular entity (see ref. 37). The 'helicity' rule is expressed by Prelog and Helmchen (see subsection 5.1, ref. 36) as: "Depending on whether the identified helix is left- or right-handed, it is designated 'minus' and marked '*M*' or 'plus' and marked '*P*'".

The application of this system to the description of conformations and configurations considers the torsion angle between two reference groups attached to the atoms at each end of a bond or an axis. The sign of the smaller torsion angle between the reference groups defines the chirality sense of the corresponding stereogenic unit (see torsion angle, P-94.2).

P-92.1.2.2.1 Stereogenic axis

The chirality of hexahelicenes is denoted by the stereodescriptors '*P*' and '*M*'.

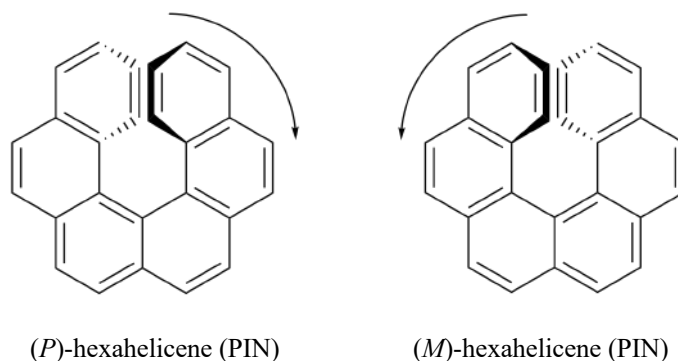

The helicity rule can also be applied to the stereogenic axis in allenes and biphenyls. Looking along the chirality axis the ligands are arranged in pairs. When proceeding from the nearer ligand having priority in the pair to the further away atom or group having priority in the pair, the chirality is described by the symbols '*M*' if the path is anticlockwise; the symbol is '*P*' if the path is clockwise. Stereodescriptors '*M*' and '*P*' are used in preferred IUPAC names. The lowest locant on the axis is cited before the stereodescriptor.

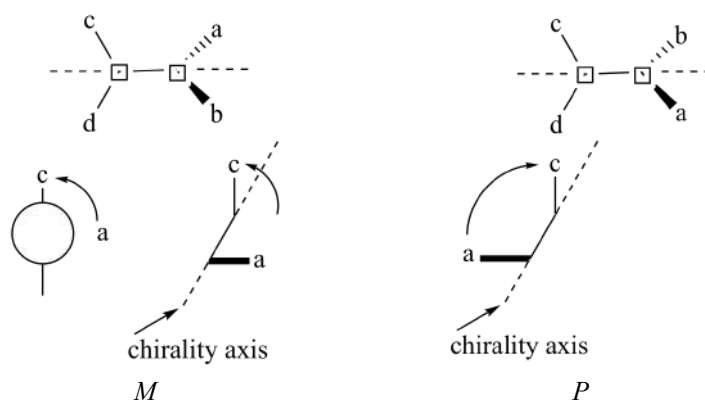

P-92.1.2.2.2 Stereogenic plane

Stereodescriptors '*M*' and '*P*' are assigned as follows:

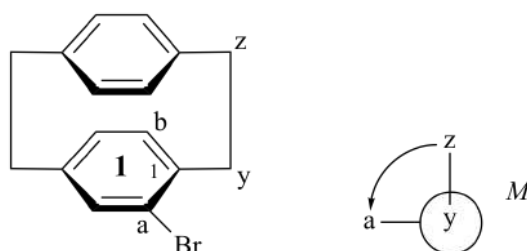

The reference plane of the molecule is described by ' $a > b$ '. The out-of-plane component is described by ' z ', attached to the in-plane axis ' $x-y$ '. A negative torsion angle is denoted when ' z ' is rotated into the plane in the direction of ' a ' that has precedence over ' b '. The stereodescriptor '*M*' is used to denote the configuration shown above. The lowest locant in the reference plane is cited before the stereodescriptor.

P-92.1.2.2.3 There is no general correspondence between '*R/S*' and '*M/P*' descriptors. In fact, using the conventions described above for the specification of the configuration, for a chirality axis ' $M = R$ ' and ' $P = S$ '; for chirality planes the opposite relationship is to be noted where ' $M = S$ ' and ' $P = R$ '.

P-92.1.3 The 'Sequence Rules'

The following 'Sequence Rules' are used (refs 34, 35, 36) to establish the order of precedence of atoms and groups. A more encompassing set of rules, proposed by Mata, Lobo, Marshall, and Johnson (ref. 41), including amendments by Custer (ref. 42) and Hirschmann and Hanson (ref. 43), is used in this Chapter.

These rules are based on the hierarchical order of ligands properties, material, and topological properties for the Sequence Rules 1 and 2, geometrical properties for Sequence Rules 3 and 4, and topographical properties for Sequence Rule 5. Properties associated with the first four Sequence Rules are reflection-invariant, while that associated with the fifth is reflection-variant.

Ligands are monodentate (monovalent, acyclic) or *n*-dentate (cyclic) as exemplified in P-92.2.1.3.

The Sequence Rules are hierarchical, i.e., each rule must be exhaustively applied in the order given until a decision is reached:

P-92.1.3.1 Sequence Rule 1 has two parts:

- (a) higher atomic number precedes lower;
- (b) a duplicate atom node whose corresponding nonduplicated atom node is the root or is closer to the root ranks higher than a duplicate atom node whose corresponding nonduplicated atom node is farther from the root.

P-92.1.3.2 Sequence Rule 2

Higher atomic mass number precedes lower;

P-92.1.3.3 Sequence Rule 3

When considering double bonds and planar tetraligand atoms '*seqcis*' = '*Z*' precedes '*seqtrans*' = '*E*' and this precedes nonstereogenic double bonds.

P-92.1.3.4 Sequence Rule 4 is best considered in three parts

Using the Sequence Rules depends on exploring along bonds. To avoid theoretical arguments about the nature of bonds, some classical forms are used. Double and triple bonds are split into two or three bonds respectively.

A $>C=O$ group is treated as $\begin{array}{c} >C-O \\ | \quad | \\ (O) \quad (C) \end{array}$ where (O) and (C) are duplicate representations of the atoms at the other end of the double bond.

Similarly, a $-C\equiv CH$ group is treated as $\begin{array}{c} (C) \quad (C) \\ | \quad | \\ -C-C-H \\ | \quad | \\ (C) \quad (C) \end{array}$ where (C) is a duplicate representations of the atoms at the other

end of the triple bond and a $-C\equiv N$ group is treated as $\begin{array}{c} (N) \quad (C) \\ | \quad | \\ -C-N \\ | \quad | \\ (N) \quad (C) \end{array}$ where (C) and (N) are duplicate representations of the atoms at the other end of the triple bond.

Only the doubly bonded atoms themselves are duplicated, and not the atoms or groups attached to them; the duplicated atoms may thus be considered as carrying three phantom atoms (see above) of atomic number zero. This may be important in deciding priorities in more complicated cases.

The simplified digraph corresponding to the ethylenic alcohol 'but-3-en-2-ol (PIN)' is as follows:

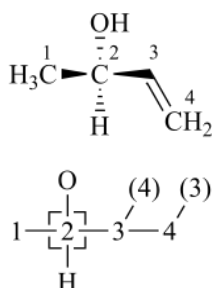

simplified digraph showing duplicate atoms

The digraph corresponding to '2-hydroxypropanal (PIN)' is as follows:

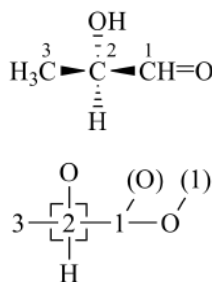

simplified digraph showing duplicate atoms

P-92.1.4.3 Saturated rings and ring systems

The methodology to transform the constitutional formula of a cyclic molecule into an acyclic digraph has been recommended by Prelog and Helmchen (see subsection 3.2, ref. 36).

In order to obtain the acyclic digraph of a stereogenic unit the n -dentate ligand is transformed into n monodentate ligands, by leaving intact in each case one bond with the core and cleaving the $n-1$ bonds. At each end of n branches thus obtained a duplicate atom of the core is attached (as in the case of multiple bonds described in P-92.1.4.2).

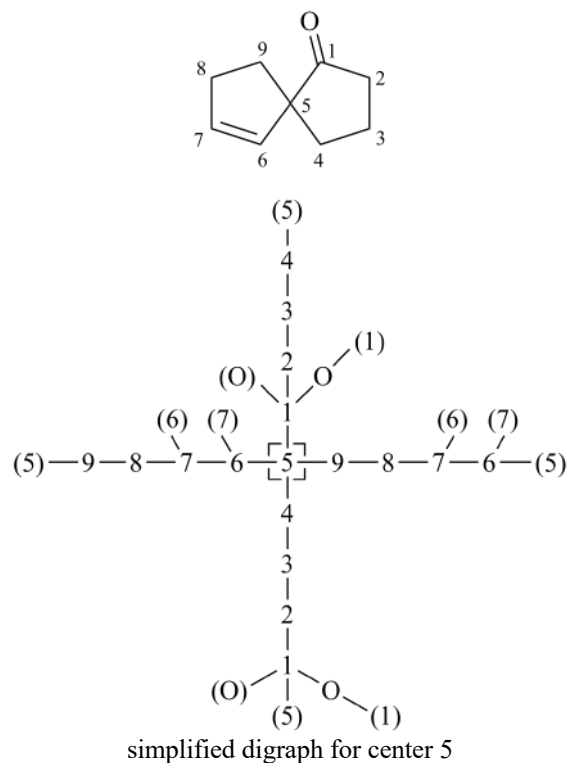

In ligands of stereogenic units containing rings, the ring opens after the first ring atom encountered when exploring each way outward from the core; one bond remains intact while the other is cleaved. A duplicate of the first encountered ring atom is attached at the end of the two branches thus obtained.

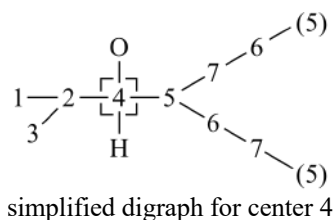
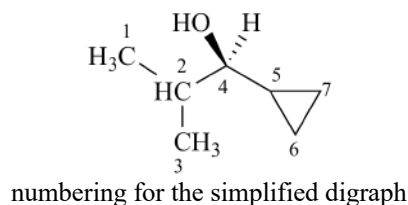
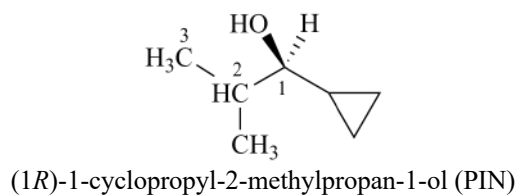

P-92.1.4.4 Mancude rings and ring systems

Mancude rings, i.e., rings or ring systems having the maximum number of noncumulative double bonds, are treated as Kekulé structures. For mancude heterocycles, each duplicate atom is given an atomic number that is the mean of what it would have if the double bonds were located at each of the possible positions. For mancude hydrocarbons, it is immaterial which Kekulé structure is used because ‘splitting’ the double bonds gives the same result in all cases.

The atomic number 6 is always present, as exemplified for a phenyl group:

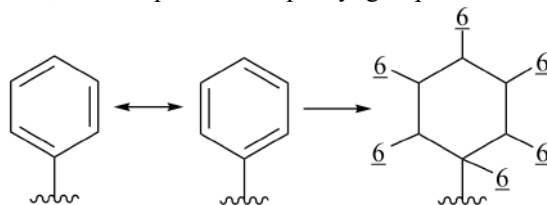

And for an example involving nitrogen atoms

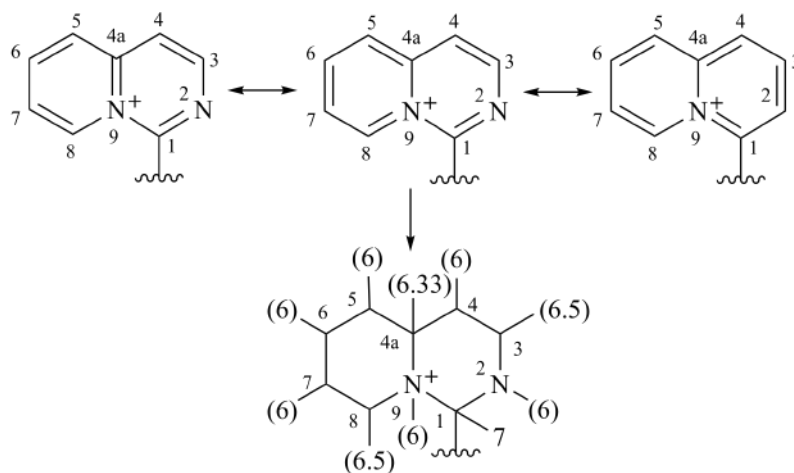

Explanation: ‘C-1’ is doubly bonded to one or the other of the nitrogen atoms and never to carbon, so its added duplicate atom has an atomic number of 7 (that of nitrogen). ‘C-3’ is doubly bonded either to ‘C-4’ (atomic number 6) and to ‘N-2’ (atomic number 7); so its added duplicate atom has an atomic number of $6\frac{1}{2}$, as it is for ‘C-8’. But ‘C-4a’ may be doubly bonded to ‘C-4’, ‘C-5’ and ‘N-9’, so its added duplicate atom has an atomic number of $6\frac{1}{3}$.

Example:

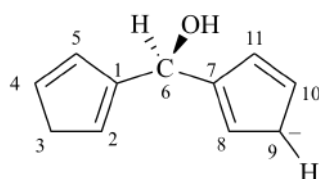

3-[(*S*)-(cyclopenta-1,4-dien-1-yl)(hydroxy)methyl]cyclopenta-2,4-dien-1-ide (PIN)

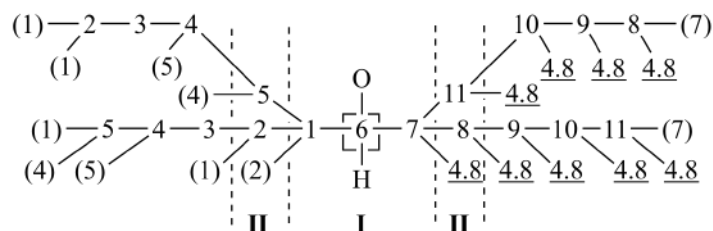

simplified digraph showing seniority of branch ‘C-1’ over ‘C-7’, because the atomic numbers 6 for ‘C-2’ > ‘4.8’ in sphere II, thus leading to an ‘*S*’ configuration for ‘C-6’.

Explanation: Five different Kekulé structures should be considered for the right hand ligand for each carbon atom in the ring. For four of them they are doubly bonded to another carbon atom; for the fifth atom the electron pair with atomic number ‘zero’ must be taken into consideration. Thus $4 \times 6 + 0 = 24$; $24/5 = 4.8$, that is the atomic number for each carbon atom in the right ligand.

P-92.1.5 Exploration of a hierarchical digraph

Digraphs are constructed to show the ranking of atoms according to the topological distance i.e., number of bonds, from the core of the stereogenic unit (i.e., center) and their evaluation by the Sequence Rules (see subsection 3.2, ref. 36).

(a) Atoms lie in spheres and atoms of equal distance from the core of the stereogenic unit are in the same sphere; spheres are identified as I, II, III, and IV, as shown in Fig. 9.1. The first sphere is occupied by the ‘proximal atoms’, ‘p’ and ‘p’’. Those in the sphere II are numbered ‘1,2,3’ and ‘1’, ‘2’, ‘3’’. Those in sphere III are numbered ‘11’, ‘12’, ‘13’, ‘21’, ‘22’, ‘23’,... ‘11’’, ‘12’’, ‘13’’... and so on for each further sphere. Indicated branches may not be present in all molecules.

(b) Atoms in the n th sphere have precedence over those in the $(n + 1)$ th sphere (Ranking Rule 1).

(c) The ranking of each atom in the n th sphere depends in the first place on the ranking of atoms of the same branch in $(n - 1)$ th sphere, and then the application of the Sequence Rules to it; the smaller the number, the higher the relative ranking (Ranking Rule 2).

(d) Those atoms in the n th sphere which are of equal rank with respect to those in the $(n - 1)$ th sphere in the same branch are ranked by means of the Sequence Rules, first by the exhaustive application of Sequence Rule 1; if no decision is reached, Sequence Rule 2 is exhaustively applied, and so on.

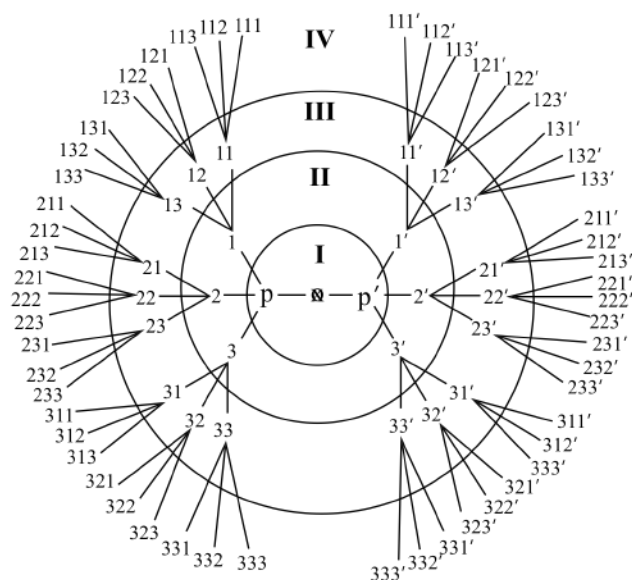

Fig. 9.1 Ranking order for two ligands

P-92.1.6 Ranking of ligands: Application of the Sequence Rules

The five 'Sequence Rules' discussed in P-92.1.3 are applied as follows:

- each rule is applied in accordance with a hierarchical digraph (see P-92.1.4)
- each rule is applied exhaustively to all ligands being compared;
- the ligand that is found to have precedence (priority) at the first occurrence of a difference in a digraph retains this precedence (priority) regardless of differences that occur later in the exploration of the digraph;
- precedence (priority) of an atom in a group established by a rule does not change on application of a subsequent rule.

P-92.2 SEQUENCE RULE 1 (consisting of two subrules)

P-92.2.1 Sequence subrule 1a: Ligands are arranged in order of decreasing atomic number.

In all examples shown below, ligands are ranked as 'a > b > c > d' for stereogenic units, unless otherwise stipulated for stereogenic axes and planes.

P-92.2.1.1 Saturated compounds

P-92.2.1.1.1 Sphere I.

Example 1:

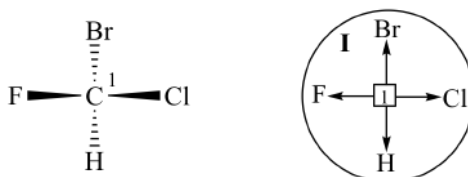

digraph for sphere I

Explanation: In the compound HCB₂ClF, all atoms are included in sphere I. The order 'a > b > c > d' is 'Br > Cl > F > H' for center '1' describing a clockwise direction; the stereodescriptor '*R*' describes this configuration, leading to the preferred IUPAC name:

(*R*)-bromo(chloro)(fluoro)methane (PIN)

Example 2:

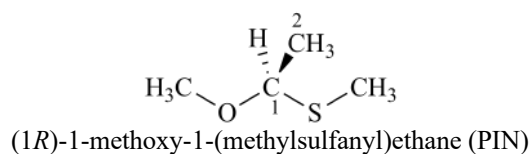

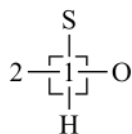

simplified digraph for sphere I

Example 3:

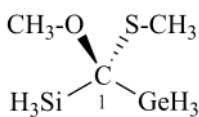

[(*R*)-germyl(methoxy)(methylsulfonyl)methyl]silane (PIN)
(the locant '1' is related to the digraph; it is not required in the name)

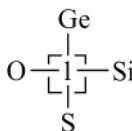

simplified digraph for sphere I

P-92.2.1.1.2 Spheres I and II

When atoms attached to the stereogenic unit are identical, precedence is established by the atoms in turn that are directly attached to the identical atoms. When the molecule contains several atoms and branches, it is convenient to number it, either by using the numbering system recommended in nomenclature or by applying an arbitrary system to properly identify all nodes appearing in the digraph.

Example 1:

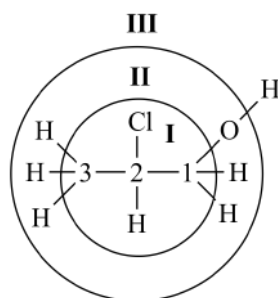
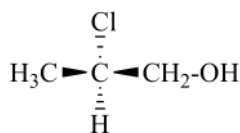

complete digraph for center 2

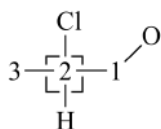

simplified digraph

Explanation: In the compound $\text{H}_3\text{C-CHCl-CH}_2\text{OH}$, above, the order of seniority for 'a > b > c > d' is 'Cl > C = C > H'. No decision is reached in sphere I, as two of the proximate atoms are identical. In sphere II, however, the atoms attached to the two carbon atoms 'C-1' and 'C-3' are 'O,H,H' and 'H,H,H', respectively, and, since 'O > H', the order of precedence is 'C-1 > C-3' and hence the group '-CH₂OH' is 'b' and the group '-CH₃' is 'c', leading to the preferred IUPAC name:

(2*R*)-2-chloropropan-1-ol (PIN)

Example 2:

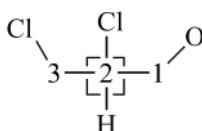
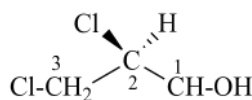

simplified digraph

Explanation: In the above compound, no decision is reached after the exploration of sphere **I**, since 'Cl > C = C > H'. In sphere **II**, a decision is reached since 'Cl > O' and therefore the '-CH₂Cl' group is 'b' and the group '-CH₂OH' group is 'c', leading to the preferred IUPAC name:

(2*S*)-2,3-dichloropropan-1-ol (PIN)

Example 3:

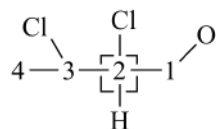
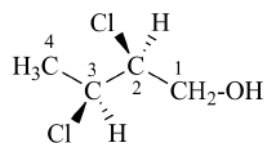

simplified digraph for '2'

Explanation: In this example, two stereogenic centers are present in the molecule; therefore two digraphs are necessary, one for each stereogenic center. The digraph for the stereogenic atom at position 2 shows the ranking 'Cl > C-3 > C-1 > H' leading to a '*S*' configuration for 'C-2'. The digraph for the stereogenic atom at position 3 shows the ranking 'Cl > C-2 > C-4 > H' leading to a '*S*' configuration for 'C-3' and the preferred IUPAC name:

(2*S*,3*S*)-2,3-dichlorobutan-1-ol (PIN)

P-92.2.1.1.3 Beyond spheres **I** and **II**

When choices remain after evaluating the second sphere, the exploration procedure is continued in the same way further away from the stereogenic center.

Example 1

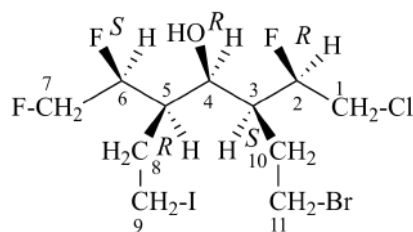

(2*R*,3*S*,4*R*,5*R*,6*S*)-3-(2-bromoethyl)-1-chloro-2,6,7-trifluoro-5-(2-iodoethyl)heptan-4-ol (PIN)

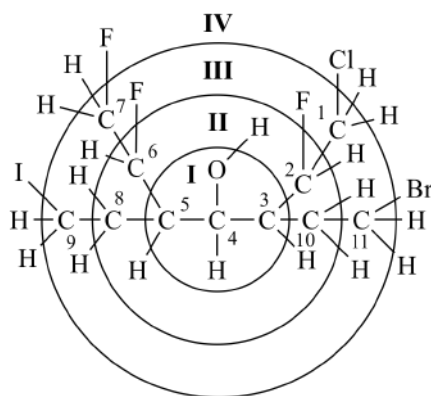

complete hierarchical digraph

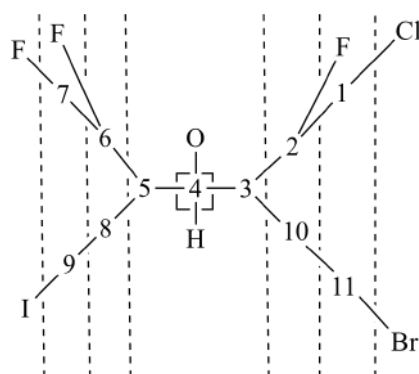

simplified digraph

Explanation: The first level of the exploration, sphere **I**, leads to 'O > C-3 = C-5 > H'; no decision can be made between the two carbon atoms. In sphere **II**, still no decision can be made, because of the two identical sets of 'C,C,H' atoms attached to the carbon atoms of sphere **I**. In sphere **III**, the two branches on the left side are ranked 'F,C,H' > 'C,H,H'; on the right side, the two branches are ranked 'F,C,H' > 'C,H,H' and still no decision can be made, but the two branches can be ranked giving precedence in further exploration to the two branches denoted by 'F,C,H' over 'C,H,H'. In sphere **IV**, the two branches having received precedence in sphere **III** are examined and a decision is reached, because 'Cl,H,H' has precedence over 'F,H,H'. Accordingly, the branch on the right hand side, 'C-3', is assigned the priority 'b' and the branch on the left hand side 'C-5', gets priority 'c'. In the branches of lower precedence in sphere **III**, there are an iodine atom and a bromine atom. The fact that iodine has priority over bromine is not taken into consideration, because a decision has already been reached.

Hierarchical digraphs should be constructed for each stereogenic unit; however construction of a simple digraph and comparison of ligands can be parallel processes and frequently a partial digraph is enough to rank ligands. Partial digraphs for centers 'C-2' and 'C-3' to establish the configuration of these chirality centers are shown below. Similar digraphs must be constructed for 'C-5' and 'C-6'.

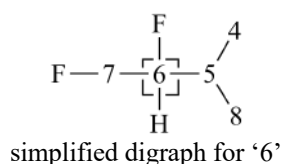
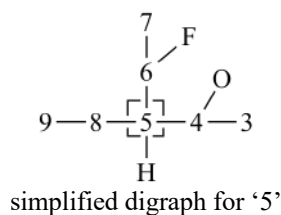
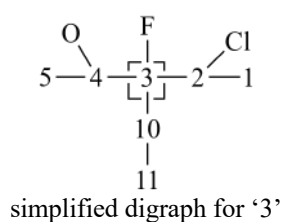
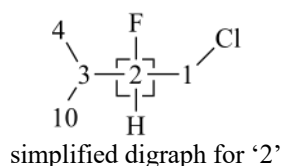

Example 2

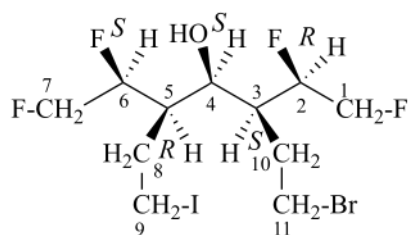

(2*R*,3*S*,4*S*,5*R*,6*S*)-3-(2-bromoethyl)-1,2,6,7-tetrafluoro-5-(2-iodoethyl)heptan-4-ol (PIN)

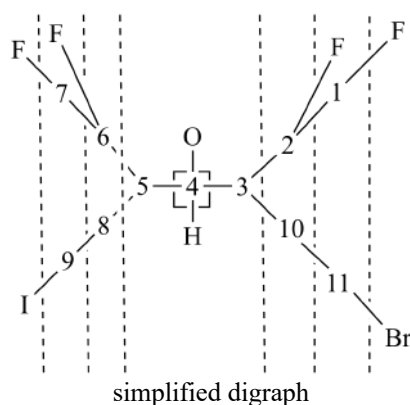

Note: This alcohol is similar to that in Example 1 above with a modification on the principal chain in which a chlorine atom has been replaced by a fluorine atom at position 1. This modification leads to an inversion of configuration of 'C-4' as discussed below.

Explanation: At 'C-4', ranking 'O > C-3 = C-5 > H' is first established. The two higher branches 'C-3,C-2,C-1' and 'C-5,C-6,C-7' cannot be differentiated. In the lower branches 'C-3,C-10,C-11' and 'C-5,C-8,C-9' a decision can be reached since 'I > Br', thus establishing the ranking order 'O > C-5 > C-3 > H' and thus the 'S' configuration for 'C-4'.

P-92.2.1.2 Double and triple bonds

Duplicate atom nodes as described in P-92.1.4.2 are used in digraphs.

Example 1:

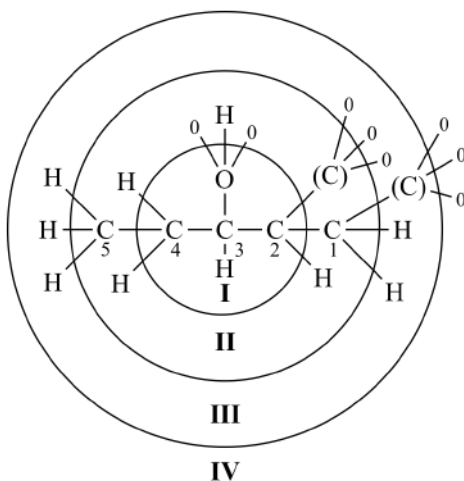
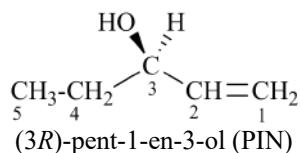

complete digraph

R

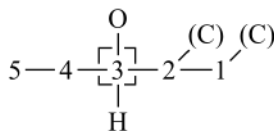

simplified digraph

Explanation: No decision can be reached in sphere I, in which 'O > C-2 = C-4 > H'. In sphere II, (C) is a duplicate carbon atom, and 'C,(C),H' has priority over 'C,H,H' and the ranking of ligands is therefore 'C-2 > C-4', leading to an 'R' configuration for the chirality center 'C-3'.

Example 2:

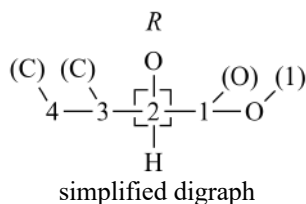
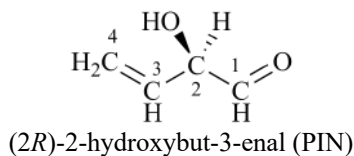

Explanation: In sphere I, the priority is established as 'O > C-1 = C-3 > H' in accordance with Sequence Rule 1. In sphere II, 'C-1 > C-3' because 'O,(O),H' for the -C=O group is senior to 'C,(C),H' for the -CH=CH₂ group, establishing the final ranking as 'O > C-1 > C-3 > H' and an 'R' configuration for the stereogenic center.

Example 3:

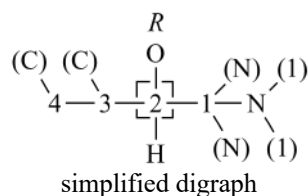
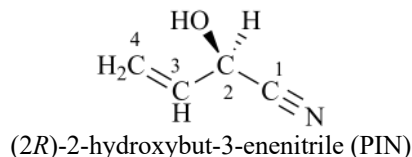

Explanation: In sphere **I**, the priority is established as ‘O > C-1 = C-3 > H’ in accordance with Sequence Rule 1. In sphere **II**, ‘C-1 > C-3’ because ‘N,(N),(N)’, for the –C≡N group, is senior to ‘C,(C),H’ for the –CH=CH₂ group, establishing the final ranking as ‘O > C-1 > C-3 > H’ and an ‘R’ configuration for the stereogenic center.

Example 4:

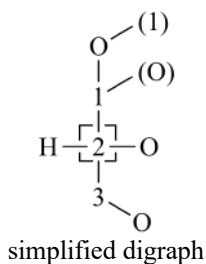
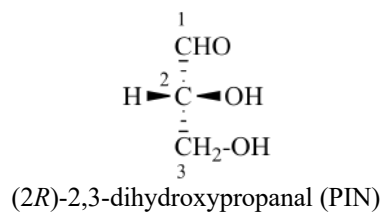

Explanation: In sphere **I** priority order established is ‘O > C-1 = C-3 > H’ in accordance Sequence Rule 1. In sphere **II**, ‘O,(O),H’ for the –CH=O group has priority over ‘O,H,H’ for the –CH₂OH group; thus establishing the final ranking as ‘O > C-1 > C-3 > H’.

P-92.2.1.3 Saturated rings and ring systems

Duplicate atoms as described in P-92.1.4.3 are used in digraphs.

Example 1 (compare with example 3, below):

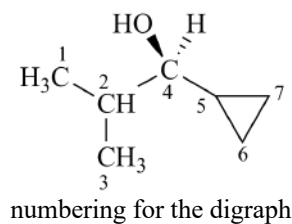
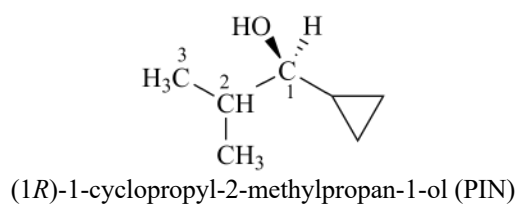

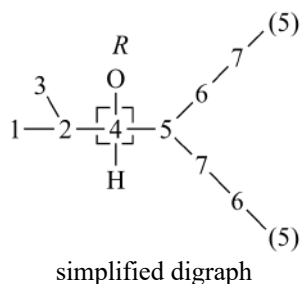
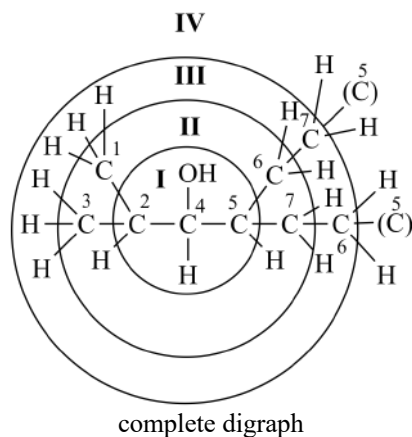

Explanation: In sphere **I**, the priority order established is ‘O > C-5 = C-2 > H’ in accordance with Sequence Rule 1. No decision is achieved in sphere **II** because the atoms bonded to both the ‘C-2 (C-1 and C-3)’ and ‘C-5 (C-6 and C-7)’ branches are ‘C,C,H’. However, in sphere **III**, both carbons bonded to ‘C-5 (C-6 and C-7)’ have ‘C,H,H’ ranking while both carbon atoms bonded to ‘C-2 (C-1 and C-3)’ have only a ‘H,H,H’ ranking; therefore the ‘C-5’ branch has priority over the ‘C-2’ branch resulting in the overall ranking of ‘O > C-5 > C-2 > H’ and an ‘R’ configuration for the stereogenic center.

Example 2

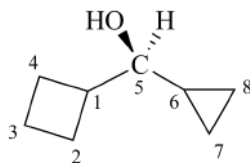

(S)-cyclobutyl(cyclopropyl)methanol (PIN)
(arbitrary numbering corresponding to the simple digraph)

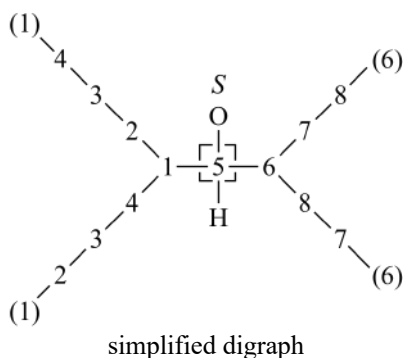

Explanation: In sphere **I** the priority order established is ‘O > C-1 = C-6 > H’ in accordance with Sequence Rule 1. No decisions can be made in spheres **II** or **III** as they are identical in both branches of the digraphs. In sphere **IV** there are only carbon atom nodes, and no decision can be reached. However, in the right branch there are only duplicated atoms and the left branch has nonduplicated atoms. Comparing atoms bonded to them in sphere **V**, there is nothing bonded to the duplicated atom and to the nonduplicated atom, ‘(C),H,H’. Since ‘(C),H,H’ has priority over “nothing”, the ‘C-1’ branch has priority over the C-6 branch, thus establishing the overall ranking ‘O > C-1 > C-6 > H’ and an ‘S’ configuration for the stereogenic center.

Example 3:

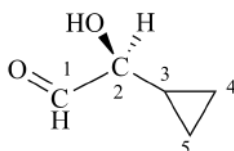

(S)-cyclopropyl(hydroxy)acetaldehyde (PIN)
(arbitrary numbering corresponding to the simple digraph)

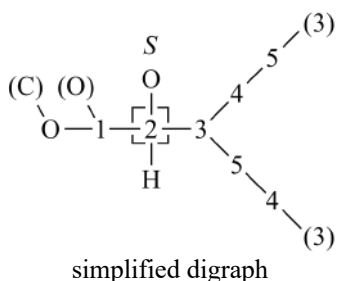

Explanation: In sphere **I** the priority order established is 'O > C-1 = C-3 > H' in accordance with Sequence Rule 1. Here, in sphere **II**, the ranking in branch 'C-1' is 'O,(O),H' but in the C-3 branch it is 'C,C,H', leading to the overall ranking of 'O > C-1 > C-3 > H' and an 'S' configuration at the stereogenic center.

Example 4 (compare with example 1 above):

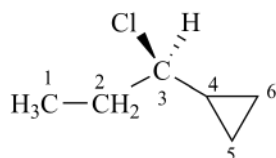

[(1R)-1-chloropropyl]cyclopropane (PIN)
(arbitrary numbering corresponding to the simple digraph)

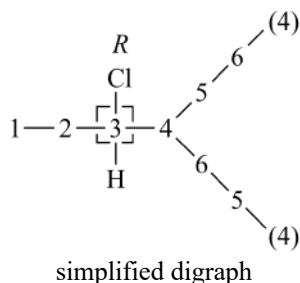

Explanation: In sphere **I** the priority order established is 'Cl > C-4 = C-2 > H' in accordance with Sequence Rule 1. Here, in sphere **II**, the ranking in branch 'C-4' is 'C,C,H' but in the C-2 branch it is 'C,H,H', leading to the overall ranking of 'Cl > C-4 > C-2 > H' and an 'R' configuration at the stereogenic center.

Example 5:

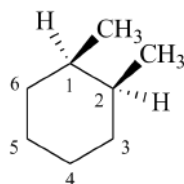

(1R,2S)-1,2-dimethylcyclohexane (PIN)

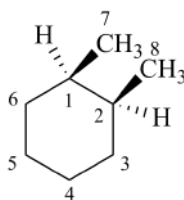

(arbitrary numbering corresponding to the simple digraph)

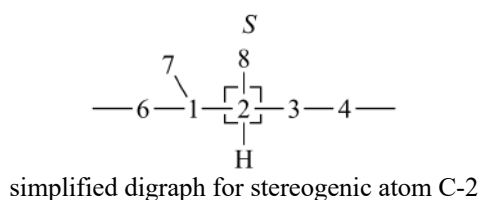
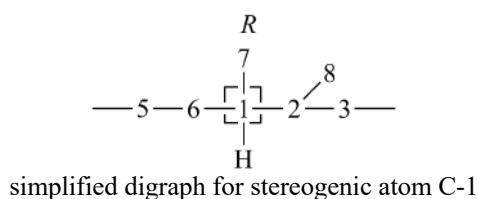

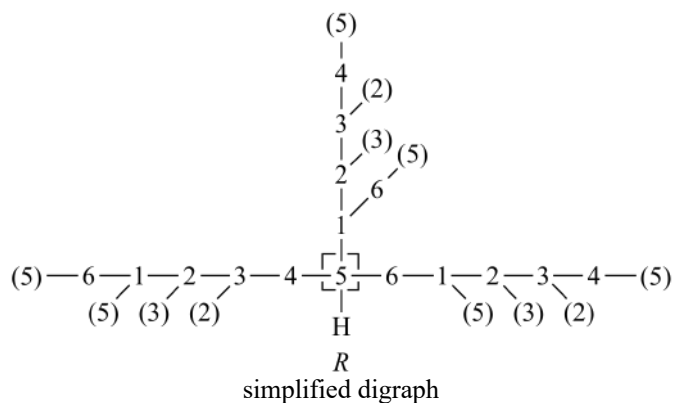

Explanation. When comparing the ‘C-4’ and ‘C-6’ ligands, they are similar, except that the first duplicate atom on the right (bonded to C-1) corresponds to the stereogenic center, whereas the first one on the left (bonded to ‘C-3’) corresponds to atoms at the third sphere ‘(C-2)’. Since a duplicate atom corresponding to an atom closer to the start of the exploration pathway precedes one that is further away, the final ranking is ‘C-1 > C-6 > C-4 > H’ and the configuration ‘R’ for the stereogenic center ‘C-5’. The digraph permits the highest priority to be given to ligand ‘C-1’ and the lowest to ‘H’.

P-92.3 SEQUENCE RULE 2. Higher atomic mass number precedes lower atomic mass number.

When isotopes are present in a molecule, Sequence Rule 1 is first applied ignoring isotopic differences between otherwise identical atoms or groups. When no decision can be reached isotopes are then taken into consideration, arranged in decreasing order of their atomic mass, i.e. ‘ $^3\text{H} > ^2\text{H} > ^1\text{H}$ (or H)’ and ‘ $^{81}\text{Br} > \text{Br} > ^{79}\text{Br}$ ’.

Example 1:

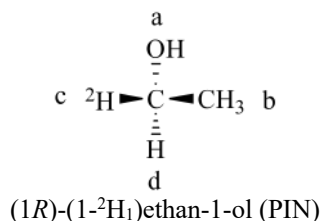

Explanation: The ranking order, ‘a > b > c > d’, after application of Sequence Rule 2, is: ‘O > C > $^2\text{H} > \text{H}$ ’ and the configuration is ‘R’ for the stereogenic center.

Example 2:

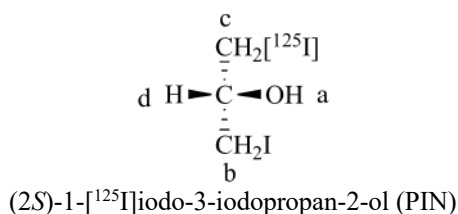

Explanation: The ranking order ‘a > b > c > d’, after application of Sequence Rule 2, is: ‘OH > CH₂I > CH₂[^{125}I] > H’ and the configuration is ‘S’ for the stereogenic center.

P-92.4 SEQUENCE RULE 3

P-92.4.1 ‘seqcis’ = ‘Z’ and ‘seqtrans’ = ‘E’

The descriptors ‘E’ and ‘Z’ are used to describe ‘cis/trans-isomers’ at diastereomorphous double bonds. The atom or group having CIP Sequence Rule precedence attached to one of a doubly bonded pair of atoms is compared with the atom or group having CIP Sequence Rule precedence attached to the other atom; if the atoms or groups having precedence are on the same side of the reference plane, the italic capital letter ‘Z’ is used as a stereodescriptor; if the atoms or groups having precedence are on opposite sides, the italic capital letter ‘E’ is used. These stereodescriptors have been coined from German; ‘Z’ is derived from ‘zusammen’ (together) and ‘E’ from ‘entgegen’ (opposite).

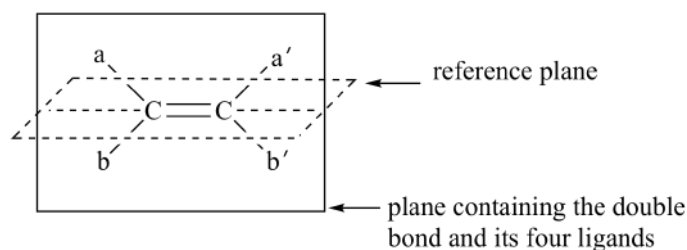

The '*E*' and '*Z*' stereodescriptors have been classified in P-91.2.1 as non-CIP stereodescriptors. The reason is that they do not distinguish between geometrically diastereomorphic double bonds whose descriptors are reflection invariant ('common' double bonds) from the geometrically enantiomorphic double bonds whose stereodescriptors are reflection variant. In the CIP system, reflection variant descriptors are capitalized (for example '*R*' and '*S*') and reflection invariant descriptors are lower-case descriptors (for example '*r*' and '*s*'). The fact that '*E*' and '*Z*' are capitalized is contrary to their reflection invariant status. Hirschman and Hanson (ref. 43) proposed to use the descriptors '*seqcis*', '*seqtrans*', '*seqCis*', and '*seqTrans*' as CIP descriptors.

When discussing configuration assignment, the CIP descriptors are used, with the understanding that '*seqcis*' = '*Z*', and '*seqtrans*' = '*E*'. In names, the descriptors '*E*' and '*Z*' are used, with the additional difficulty that the traditional '*cis*' relationship is 'senior' to '*trans*' relationship in the numbering of compounds containing diastereomorphic double bonds is translated into '*Z*' is senior to '*E*', irrespective of the alphabetical order.

Example:

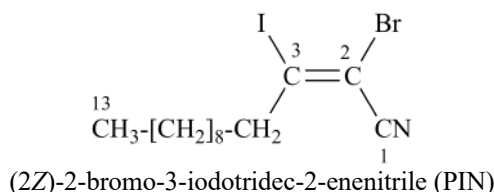

Explanation: In this compound, application of Sequence Rule 1 described in P-91.2.1 gives precedence to 'I' over the carbon chain in position '3'; similarly, in position 2, 'Br' has precedence over the 'C' of the CN group. Thus the configuration of the double bond is '*Z*', the atoms 'I' in position '3' and 'Br' in position '2' being compared.

P-92.4.2 Sequence Rule 3: '*seqcis*' ('*Z*') precedes '*seqtrans*' ('*E*') and this order precedes nonstereogenic double bonds

P-92.4.2.1 The application of Sequence Rule 3 leads to the specification of the configuration of compounds containing sets of '*cis*' and '*trans*' double bonds when the direct application of Sequence Rules 1 or 2 does not permit a conclusion to be reached (see Mata, Lobo, Marshall, and Johnson, ref. 41).

Example 1:

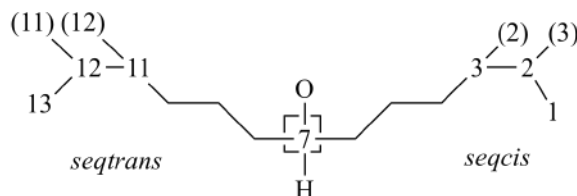
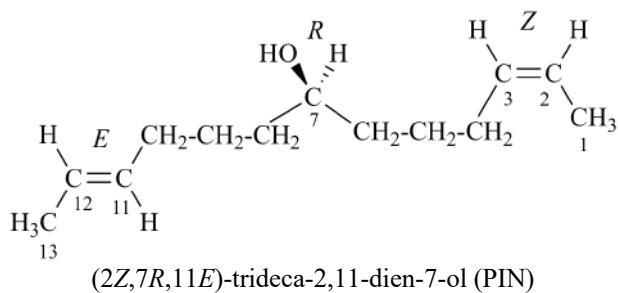

simplified digraph for establishing the ranking *seqcis* = (*Z*) > *seqtrans* = (*E*) and the '*R*' configuration for '*C-7*'

Example 2:

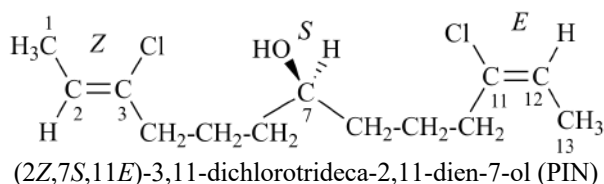

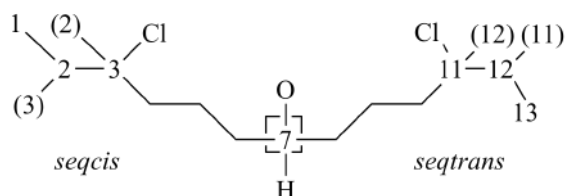

simplified digraph for establishing the ranking *seqcis* (*Z*) > *seqtrans* (*E*)
and the '*S*' configuration for 'C-7'

P-92.4.2.2 Auxiliary stereodescriptors are used when direct assignment of configuration cannot be made to double bonds. In the following example, the four-membered ring is opened to generate a digraph as discussed in P-92.2.1.3, thus creating two branches each containing a double bond whose configuration is '*seqcis*' (*Z*) in one case and '*seqtrans*' (*E*) in the other considering the ligands as they appear in the digraph. The assignment of these stereodescriptors is transitory, but permits a definitive configuration to be assigned to the remaining double bond located at 'C-3' by using the Sequence Rule 3, '*seqcis* > *seqtrans*'. The definitive stereodescriptor is thus '*E*' for the ethylidene substituent located at position '1', and also '*E*' for the ethylidene group located at position '3'.

Example 1:

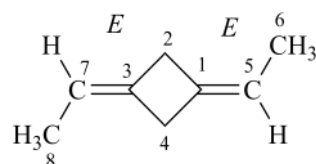

(1*E*,3*E*)-1,3-diethylidenecyclobutane (PIN)
1,3-di[(*E*)-ethylidene]cyclobutane
(*E*)-1,3-diethylidenecyclobutane

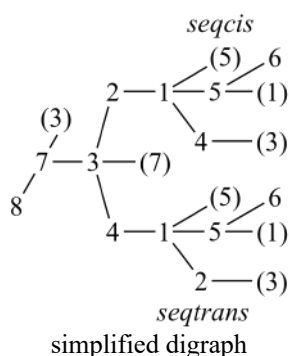

Explanation: To specify double bonds, ligands of both double bond atoms should be ranked. This is straightforward for the ligands of 'C-5' and 'C-7'. However the ranking of ligands at 'C-1' and 'C-3' is a complex process, and requires the use of auxiliary descriptors. The following digraph, with a specific numbering, shows configuration '*E*' at 'C-3'. As the digraph is acyclic, it is possible to specify the double bond 'C-1', using the ligands as they appear in the digraph. These are auxiliary descriptors that are different in branches 'C-2' and 'C-4' and allow the ligands to be ranked, 'C-2 > C-4'.

In names, the stereodescriptor '*E*' is used to describe each double bond; the two stereodescriptors are placed at the front of the name, in parentheses, each preceded by the locant indicating the position of the double bond on the ring. This method is used in preferred IUPAC names. It is preferred to the method which attributes the double bond to the substituent group and cites the required stereodescriptor(s) at the front of the substituent group. A third method considers that the stereodescriptor '*E*' describes the whole molecule, considered as an extended double bond.

Example 2:

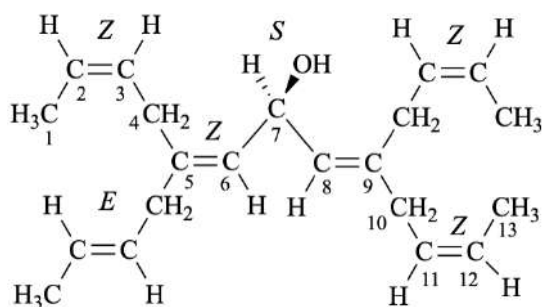

(2*Z*,5*Z*,7*S*,11*Z*)-5-[(2*E*)-but-2-en-1-yl]-9-[(2*Z*)-but-2-en-1-yl]trideca-2,5,8,11-tetraen-7-ol (PIN)

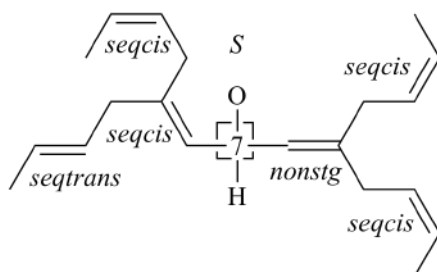

simplified digraph showing stereogenic (*seqcis* and *seqtrans*) and nonstereogenic (*nonstg*) units

Explanation: When comparing double bonds the first to be compared (starting from the core of the digraph) are the 'C-5' double bond that is '*seqcis*' and the 'C-9' double bond that is nonstereogenic. As a '*seqcis*' configuration precedes a nonstereogenic one, the ranking of the ligands is: 'OH > C-6 > C-8 > H' and the configuration of the chirality center is '*S*'.

P-92.5 SEQUENCE RULE 4

When the use of Sequence Rules 1, 2, and 3 does not permit the determination of the ranking of all ligands of a stereogenic unit, Sequence Rule 4 is applied as described here. For the purpose of this Section, Sequence Rule 4 is simplified and discusses only the stereodescriptors most encountered in nomenclature of organic compounds, i.e. '*R*', '*S*', '*r*', and '*s*'.

It is important to note that full digraphs are necessary for the analysis of all stereogenic units. Descriptors specified in digraphs may correspond to the final descriptors or to temporary (auxiliary) descriptors used only for ranking ligands and never appearing as final descriptors.

A simplified version of Sequence Rule 4 that only considers stereogenic centers is expressed as follows:

- (a) chiral stereogenic units precede pseudoasymmetric stereogenic units and these precede nonstereogenic units;
- (b) When two ligands have different descriptor pairs, then the one with the first chosen *like* descriptor pairs has priority over the one with a corresponding *unlike* descriptor pair:
 - (i) *Like* descriptor pairs are: '*RR*', '*SS*';
 - (ii) *Unlike* descriptor pairs are '*RS*', '*SR*';
- (c) '*r*' precedes '*s*'.

It is convenient to divide Sequence Rule 4 into three subrules.

P-92.5.1 Sequence Rule 4a

Chiral stereogenic units precede pseudoasymmetric stereogenic units and these precede nonstereogenic units.

Example:

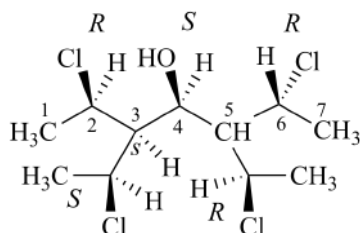

(2*R*,3*s*,4*S*,6*R*)-2,6-dichloro-5-[(1*R*)-1-chloroethyl]-3-[(1*S*)-1-chloroethyl]heptan-4-ol (PIN)

Note: The numbering of the principal chain is based on lowest locants for stereogenic centers; the stereodescriptor set '*2R,4S,6R*' in the principal chain is preferred to '*2S,4S,6R*' according to Sequence Rule 5 (see P-92.6).

Explanation: The molecule is renumbered in preparation for the construction of digraphs. According to P-92.1.4.1 digraphs of all stereogenic centers are constructed, thus allowing the specification at 'C-2', 'C-6', 'C-8', and 'C-10'. Digraphs are also constructed for specifying the configuration of 'C-3' and 'C-5'. The configuration at 'C-2', 'C-6', and 'C-10' is determined as '*R*' by applying Sequence Rule 1; the configuration at 'C-8' is '*S*' by applying the same rule. The configuration at 'C-3' is determined as '*s*' by ranking two of the ligands by Sequence Rule 5 (see below, '*R*' precedes '*S*'); 'C-5' is a nonstereogenic center as it is substituted by two identical groups (both chirality centers are '*R*'). The simple digraphs needed for the specification of 'C-4' are shown below.

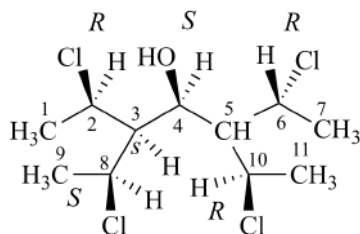

arbitrary renumbered molecule for the simplified digraphs below.

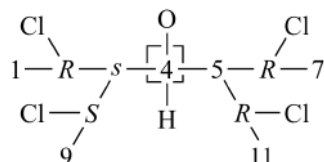
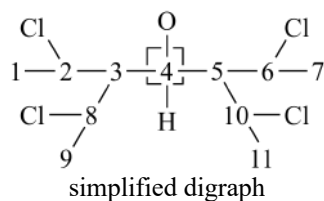

a first simplified digraph modified by introducing configurations at 'C-2', 'C-3', 'C-6', 'C-8', and 'C-10', as determined above.

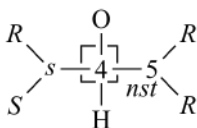

further simplified digraph to show the relevant information necessary to determine the configuration at 'C-4'.

Explanation: Final simplified digraph showing that the four ligands around the stereogenic unit 'C-4' are different and can be ranked: 'OH > pseudoasymmetric stereogenic unit > nonstereogenic unit (nst) > H'. Hence, the configuration for 'C-4' is 'S'.

P-92.5.2 Sequence Rule 4b

When two ligands have different descriptor pairs, then the one with the first chosen *like* descriptor pairs has priority over the one with a corresponding *unlike* descriptor pair.

(i) *Like* descriptor pairs are: 'RR', 'SS':

(ii) *Unlike* descriptor pairs are: 'RS', 'SR'

P-92.5.2.1 Methodology for pairing ligands

A new methodology has recently been described by Mata and Lobo (ref. 41) to replace that described by Prelog and Helmchen (see subsection 5.4, ref. 36). The rule for pairing stereodescriptors is as follows: A reference descriptor for chirality centers, identified as **R** or **S** (not associated with any node of the digraph and designated here with a bold font), is chosen in each ligand and is:

(a) the one associated with the highest rank node corresponding to a chiral unit in the ligand;

(b) the one that occurs the most in the set of equivalent highest rank nodes; or

(c) sequentially both descriptors (**R** and **S**), if these occur in the same number in the set of equivalent highest ranked nodes:

(i) If the number of reference descriptors is different in both ligands then the ligand with one reference descriptor has priority over the one with two reference descriptors;

(ii) If both ligands have the same number of reference descriptors, then the reference descriptor is paired with each one of the descriptors, identified as **R** or **S**, associated with nodes corresponding to chiral units, respecting their connectivity and hierarchy in the digraph.

In the following digraph (see example 1 in P-92.5.2.2) the configuration at 'C-4' is determined by the four ligands 'Cl', 'H' and the two branches 'C-3,C-2,C-1' (right branch) and 'C-5,C-6,C-7' (left branch) showing the connectivity and the hierarchical order of nodes.

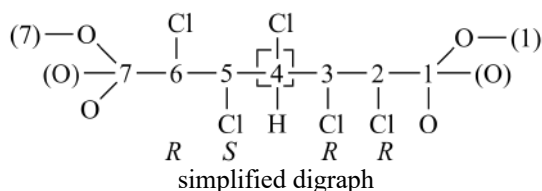

The descriptors ‘*R*’ and ‘*S*’ shown in the digraph for chirality centers at ‘C-2’, ‘C-3’, ‘C-5’, and ‘C-6’ are determined by Sequence Rule 1; the reference descriptors ‘*R*’ or ‘*S*’ are chosen according to the hierarchical order of nodes, ‘C-3’ for the right branch and ‘C-5’ for the left branch; thus ‘*R*’ is chosen for the right branch, as ‘C-3’ is ‘*R*’; the descriptor ‘*S*’ is chosen for the left branch, as ‘C-5’ is ‘*S*’. Then, the pair ‘*RR*’ is established for the nodes ‘C-3’ and ‘C-2’; the pair ‘*SS*’ is established for node ‘C-5’ and the pair ‘*SR*’ for the node ‘C-6’. The pairs ‘*RR*’ and ‘*SS*’ are *like* descriptor-pairs; the pairs ‘*SR*’ and ‘*RS*’ are *unlike* descriptors-pairs. The Sequence Rule 4 is applied to pairs containing the reference descriptors; they are compared in the hierarchical order of their nodes, ‘C-3’ and ‘C-5’, then ‘C-2’ and ‘C-6’. No decision can be reached by the comparison of the two *like* pairs ‘*RR*’ at ‘C-3’ and ‘*SS*’ at ‘C-5’; the comparison between the *like* pair ‘*RR*’ at ‘C-2’ and the *unlike* pair ‘*SR*’ at ‘C-6’ leads to the decision the branch with the *like* pair has priority over the branch with the *unlike* pair. The final order of ligands ‘Cl > C-3 > C-5 > H’ determines the ‘*R*’ configuration for the chiral center ‘C-4’.

P-92.5.2.2 Application of the methodology in P-92.5.2.1 is illustrated by the following examples; the criteria in P-92.5.2.1 are applied in the order (a), (b), (c), (i), and (ii) as required. Examples 1 through 4 are related to criterion (a); example 5 to criterion (b); example 6 to subcriterion (i) following (c). Example 6 in P-92.6 illustrates criterion (c).

Example 1:

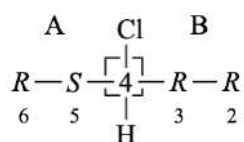
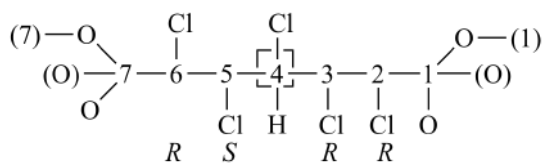
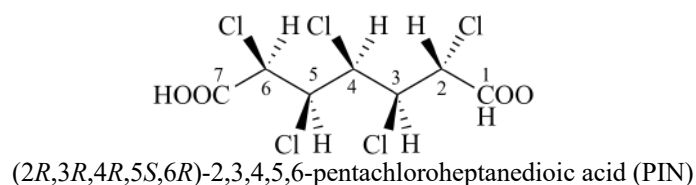

reference descriptor

S *R*

pairs of descriptors

S,5 → *l* *R*,3 → *l*

S,6 → *u* ↔ *R*,2 → *l*

A < B

Explanation: In this example, the configuration at ‘C-2’, ‘C-3’, ‘C-5’, and ‘C-6’ is determined by the ranking of the ligands by Sequence Rule 1. In each branch (ligand) A and B of the digraph, the highest ranked node is chosen as reference descriptor, ‘*R*’ for the B branch and ‘*S*’ for the A branch. Pairs of descriptors are formed by pairing the reference descriptor and each descriptor (denoted by its locant) starting from the core of the digraph; they are described as ‘*l*’ or ‘*u*’, *like* pairs being ‘*RR*’ or ‘*SS*’, *unlike* pairs being ‘*RS*’ or ‘*SR*’. The comparison of pairs between branches is achieved according to the decreasing hierarchical ranking. At the first difference, the *like* pair has precedence over the *unlike* pair, leading to the ‘*R*’ configuration for ‘C-4’.

Example 2:

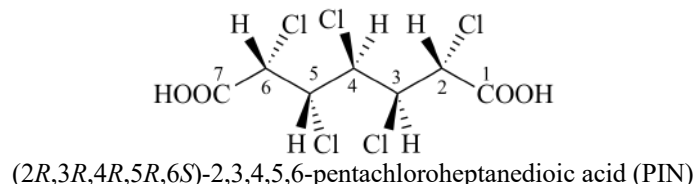

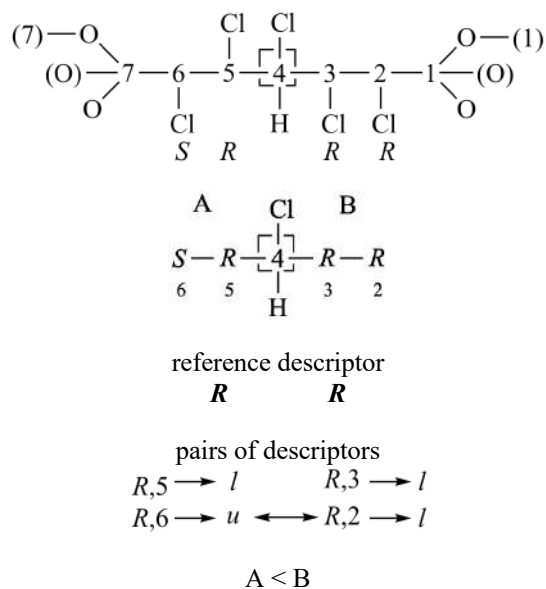

Explanation: In this example, the configuration at ‘C-2’, ‘C-3’, ‘C-5’, and ‘C-6’ is determined by application of Sequence Rule 1. In each branch (ligand) A and B of the digraph, the highest ranked node is chosen as reference descriptor, ‘**R**’ for the two branches. Pairs of descriptors are formed by pairing the reference descriptor and each descriptor (denoted by its locant) starting from the core of the digraph; they are described as ‘*l*’ or ‘*u*’, *like* pairs being ‘**RR**’ or ‘**SS**’, *unlike* pairs being ‘**RS**’ or ‘**SR**’. The comparison of pairs between branches is achieved according to the decreasing hierarchical ranking. At the first difference, the *like* pair has precedence over the *unlike* pair, leading to the ‘**R**’ configuration for ‘C-4’.

Example 3.

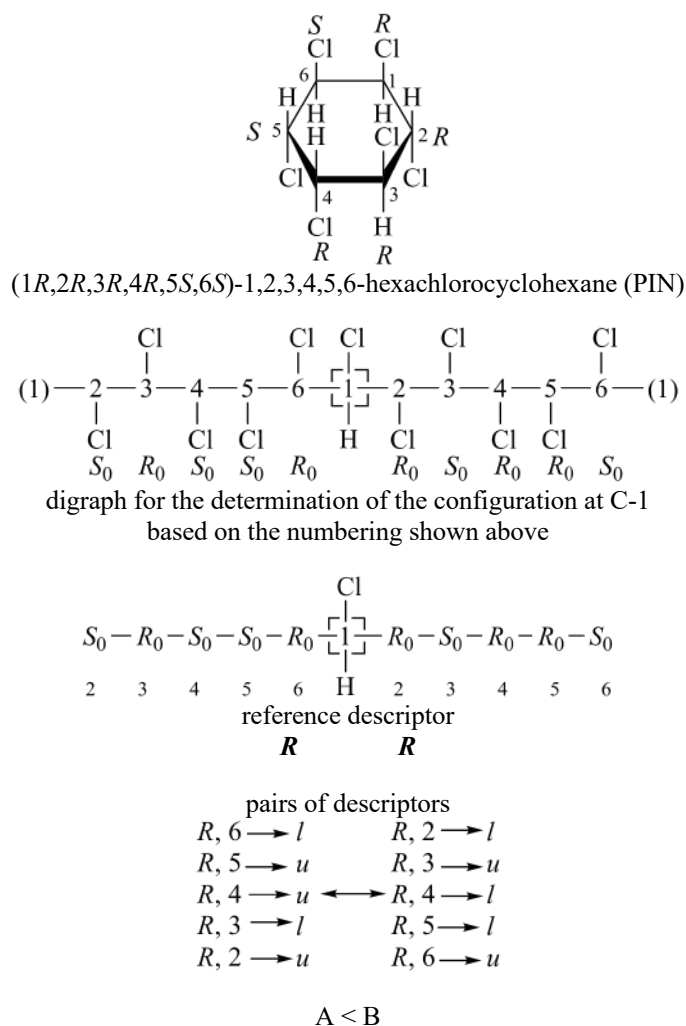

Explanation: This example illustrates the use of reference descriptors and that of auxiliary descriptors, R_0 and S_0 , specified in place of usual stereodescriptors R and S as described by Prelog and Helmchen (see 6.2.1 in ref. 36). The first step consists in establishing a digraph showing auxiliary descriptors (R_0 and S_0) illustrated here for C-1. The auxiliary descriptors for every node are determined for this digraph. For example, the auxiliary descriptor for C-6 node is R_0 as $\text{Cl} > \text{C-1} > \text{C5} > \text{H}$. Once all necessary auxiliary descriptors are assigned, the methodology described by Mata

and Lobo for pairing descriptors is then applied. In this example, reference descriptors are chosen in accordance with the highest ranked nodes in the A and B branches: both reference stereodescriptors are 'R'. The analysis of the pairing of descriptors leads to the precedence of branch B over branch A, and the 'R' configuration for 'C-1'.

Example 4:

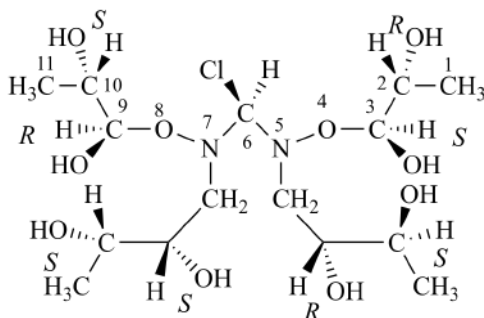

(2*R*,3*S*,6*R*,9*R*,10*S*)-6-chloro-5-[(2*R*,3*S*)-2,3-dihydroxybutyl]-7-[(1*S*,2*S*)-2,3-dihydroxybutyl]-4,8-dioxo-5,7-diazaundecane-2,3,9,10-tetrol (PIN;

in the principal chain, named by skeletal replacement nomenclature, both pairs of stereodescriptors are *unlike*; so the stereodescriptor *R* is assigned to the lowest locant, '2')

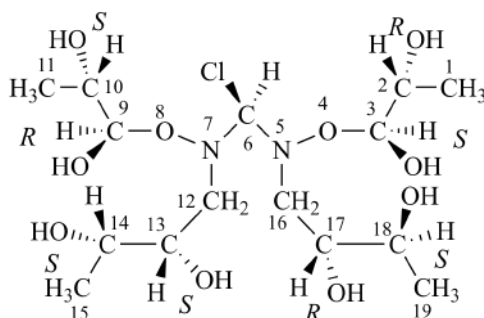

arbitrary numbering used in the construction of the digraph for at C-6

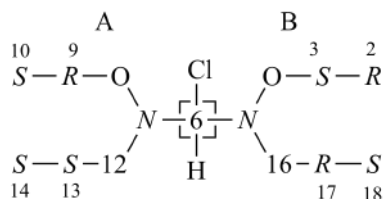

reference descriptor

R *S*

pairs of descriptors

R, 9 → *l* *S*, 3 → *l*
R, 13 → *u* *S*, 17 → *u*
R, 10 → *u* *S*, 2 → *u*
R, 14 → *u* ↔ *S*, 18 → *l*

A < B

The seniority of B over A leads to the 'R' configuration for C-6.

Explanation: First, the structure is renumbered as shown above. Then, the configurations at 'C-2', 'C-3', 'C-9', 'C-10', 'C-13', 'C-14', 'C-17', and 'C-18' are determined by the ranking of the ligands by Sequence Rule 1. However, Sequence Rule 1 does not allow to rank two of the ligands of chirality center 'C-6', and pairs of descriptors of their chiral units are compared according to Sequence Rule 4. The ranking of the chirality centers in both ligands of 'C-6', previously defined by the application of Sequence Rule 1, is for branch A 'C-9' > 'C-13' > 'C-10', > 'C-14' and for branch B 'C-3' > 'C-17' > 'C-2', > 'C-18'. The next step is to choose the reference descriptor 'R' or 'S', based on the one associated with the highest ranking chiral unit in each of the ligands. It is 'R' for branch A and 'S' for branch B. Finally the pairing of descriptors is made, respecting the connectivity and hierarchy in the digraph. At the first difference, the *like* pair has precedence over the *unlike* pair, thus establishing the precedence of branch B over branch A, leading to the configuration 'R' for 'C-6'.

Example 5:

This example illustrates the application of criterion (b) of the rule described in P-92.5.2.1.

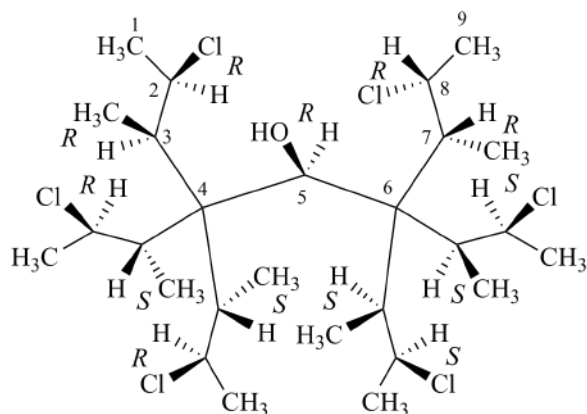

(2*R*,3*R*,5*R*,7*R*,8*R*)-2,8-dichloro-4,4-bis[(2*S*,3*R*)-3-chlorobutan-2-yl]-6,6-bis[(2*S*,3*S*)-3-chlorobutan-2-yl]-3,7-dimethylnonan-5-ol (PIN;

the principal chain contains two pairs of stereodescriptors, one *like*, the other *unlike*;
lowest locants are assigned to the *like* pair)

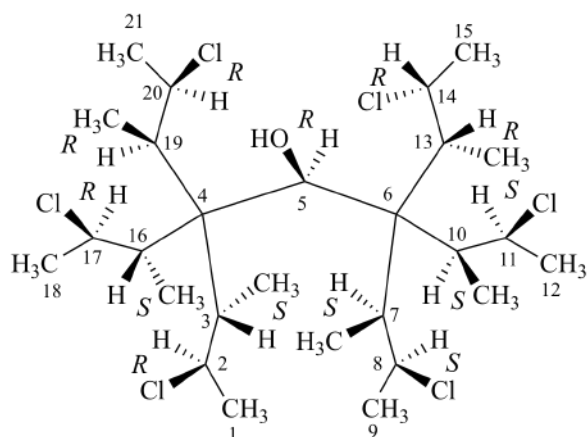

arbitrary numbering used in the construction of the digraph at 'C-5'

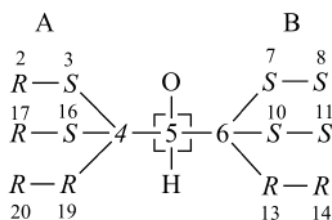

reference descriptor
S *S*

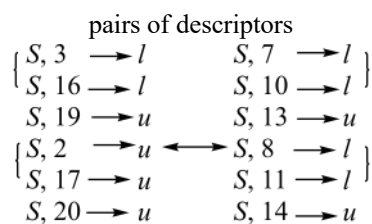

final result
S lluuuu *S llullu*

A < B

The seniority of B over A leads to the '*R*' configuration for C-6.

Explanation: First the structure is renumbered as shown above. Then, configurations at 'C-2', 'C-3', 'C-7', 'C-8', 'C-10', 'C-11', 'C-13', 'C-14', 'C-16', 'C-17', 'C-19' and 'C-20' are established by the application of Sequence Rule 1. Achiral centers are present at 'C-4' and 'C-6'. The determination of the configuration at 'C-5' is illustrated below in accordance with the shown digraph. Next, the reference descriptors are chosen. In the left branch nodes in sphere II are hierarchically equivalent, two of them are '*S*' and the other is '*R*'. Thus, the reference descriptor is '*S*'; it is the one that occurs most in the set of equivalent highest ranked nodes. Similarly, in the right branch the reference descriptor is '*S*'.

The hierarchy used in the comparison of the pairs of descriptors is established as follows. After reordering the three nodes in sphere **II** of the digraph (nodes bonded to 'C-4' in the left branch and to 'C-6' in the right branch), the nodes are no more equivalent. Those that form *like* pairs have precedence over the one that forms an *unlike* pair. Similarly, the ranking in branch B gives precedence to *like* pairs.

The analysis of the digraph leads to the conclusion that the comparison of pairs establishes, at the first difference, the priority of the pair *S*,8 and *S*,11 (*like pair*) over the pair *S*,2 and *S*,17 (*unlike pair*) leading to the priority of the branch B over the branch A, and to the configuration 'R' at 'C-5'. The reordering of the digraph is always required when applying the Sequence Rules. Before comparison according to Sequence Rule **4b**, partial digraphs 1, 2, and 3 below (nodes at top of the digraph are equivalent or higher ranked than those nodes closer to the bottom of the digraph) are all valid to represent branch A. However, after comparison of sphere **II** only digraph 1 represents the hierarchy of the nodes.

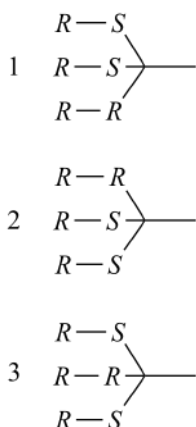

Example 6:

This example illustrates criterion (i) described in the methodology recommended by Mata and Lobo (see P-92.5.2.1), which is: If the number of reference descriptors is different in both ligands then the ligand with one reference descriptor has priority over the one with two reference descriptors.

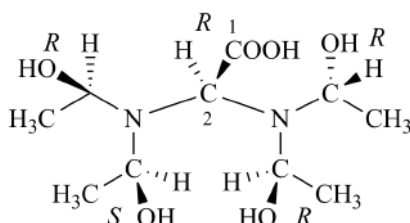

(*R*)-{bis[(1*R*)-1-hydroxyethyl]amino} {[(1*R*)-1-hydroxyethyl] [(1*S*)-1-hydroxyethyl] amino} acetic acid (PIN)

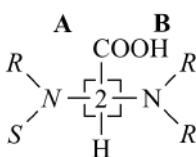

simplified digraph for the specification of the configuration at C-2

Explanation: In branch A, both descriptors ('*R*' and '*S*') are used as reference descriptors; in branch B, there is only one reference descriptors ('*R*'); thus, the ligand B ranks higher, leading to '*R*' configuration for 'C-2'.

P-92.5.3 Sequence Rule 4c: '*r*' precedes '*s*'

Example:

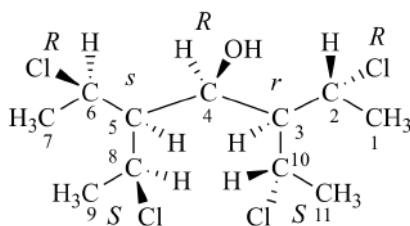

(2*R*,3*r*,4*R*,5*s*,6*R*)-2,6-dichloro-3,5-bis[(1*S*)-1-chloroethyl]heptan-4-ol (PIN)

Note: According to Sequence Rule **4a(b)** in P-92.5.2.1, the locant set '(2*R*,4*R*,6*R*)' has priority over '(2*R*,4*R*,6*S*)'. In the principal chain, the lower locant '3' is given to the pseudoasymmetric center '*r*'.

Explanation: The configuration at 'C-2' and 'C-6' is determined as '*R*' by applying Sequence Rule 1; by the same rule, the configuration is at 'C-8' and 'C-10' is '*S*'. The configuration at 'C-5' is determined as '*s*' by applying Sequence Rule 5 (see below, '*R*' precedes '*S*'); by the same rule the configuration at 'C-3' is '*r*'. By the procedure described in P-92.5.2.1 above, the following simplified digraphs are constructed:

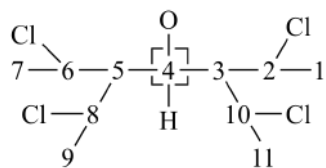

a first simplified digraph is constructed

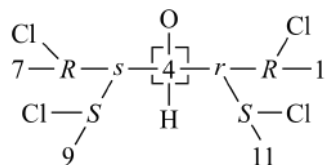

simplified digraph indicating the configuration of the chiral and pseudoasymmetric centers

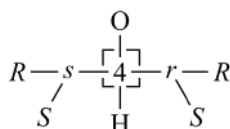

By applying the rule '*r*' precedes '*s*', the configuration at 'C-4' is '*R*'.

P-92.6 SEQUENCE RULE 5: '*R*' precedes '*S*', '*M*' precedes '*P*', and '*seqCis*' precedes '*seqTrans*', and similarly for auxiliary descriptors.

In preferred IUPAC names the lower case stereodescriptors '*r*' and '*s*' are used to describe pseudoasymmetric centers, and '*m*' and '*p*' describe axial or planar pseudoasymmetry. These stereodescriptors are invariant on reflection. In contrast, two chiral ligands of opposite configuration on the same position of a double bond generate geometrically enantiomorphic double bonds denoted by the stereodescriptors '*seqCis*' or '*seqTrans*'; such configurations are reflection-variant (see Example 5, below). For '*seqCis*' precedes '*seqTrans*' see Example 4 in P-93.5.1.4.2.2.

Example 1:

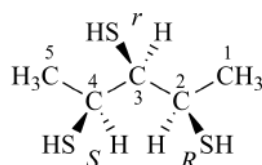

(2*R*,3*r*,4*S*)-pentane-2,3,4-trithiol (PIN)

Explanation: The configurations at 'C-2' and 'C-4' are determined by applying Sequence Rule 1. The configuration '*r*' at 'C-3' is arrived at in accordance with the sequence '*S* > C-2 > C-4 > H'.

Example 2:

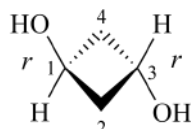

(1*r*,3*r*)-cyclobutane-1,3-diol (PIN)

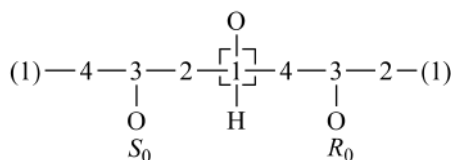

simplified digraph

Explanation: The following digraph specifies the configuration '*r*' for 'C-1', in accord with the rule '*R*' precedes '*S*'. In the same way, configuration '*r*' at C-3 is determined. Auxiliary descriptors '*R*₀' and '*S*₀' are used in place of usual descriptors specified by applying Sequence Rule 1 (see Prelog and Helmchen, subsection 6.2.1, ref. 36).

Example 3:

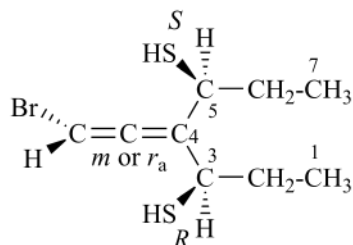

(3*R*,4*m*,5*S*)-4-(2-bromoethen-1-ylidene)heptane-3,5-dithiol (PIN)
 (3*R*,4*r_a*,5*S*)-4-(2-bromoethen-1-ylidene)heptane-3,5-dithiol

Explanation: The configurations at 'C-3' and 'C-5' are determined by applying Sequence Rule 1. The configuration '*m*' or '*r_a*' at 'C-4' is determined in accordance with the methodology described in P-92.1.2.1.2 (see also P-93.5.7.1).

Example 4:

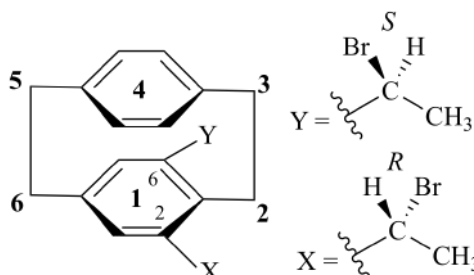

(1^{1*m*})-1²-[(1*R*)-1-bromoethyl]-1⁶-[(1*S*)-1-bromoethyl]-1,4(1,4)-dibenzenacyclohexaphane (PIN)
 (1^{1*s_p*})-1²-[(1*R*)-1-bromoethyl]-1⁶-[(1*S*)-1-bromoethyl]-1,4(1,4)-dibenzenacyclohexaphane

Explanation: The configurations for 'X' and 'Y' are determined by applying Sequence Rule 1. The configuration '*m*' or '*s_p*' at 'C-11' is determined in accordance with the methodology described in P-92.1.2.1.3 and P-92.1.2.2.2 (see also P-93.5.5.1).

Example 5:

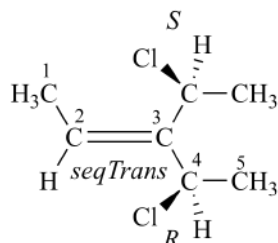

(2*seqTrans*,4*R*)-4-chloro-3-[(1*S*)-1-chloroethyl]pent-2-ene (PIN)

Explanation: 'The configurations at 'C-4' and for the side chain are determined by applying Sequence Rule 1. The configuration '*seqTrans*' is determined in accordance with the methodology described in P-92.4.1, priority being assigned to '*R*' over '*S*' on the same side of the reference plane.

Example 6:

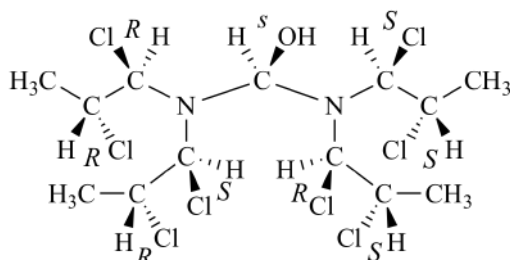

(*s*)--{[(1*R*,2*R*)-1,2-dichloropropyl][(1*S*,2*R*)-1,2-dichloropropyl]amino} {[(1*R*,2*S*)-1,2-dichloropropyl][(1*S*,2*S*)-1,2-dichloropropyl]amino} methanol (PIN)

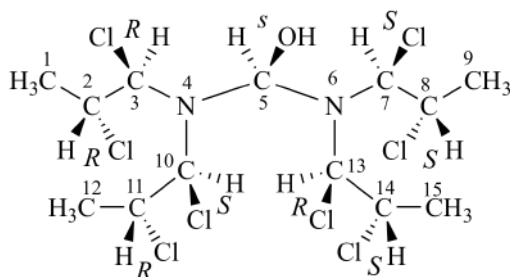

arbitrary numbering used in the construction of the graph for at 'C-5'

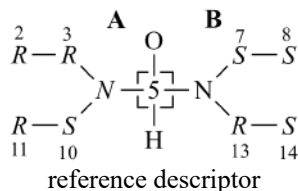

<i>R</i>	reference descriptor	<i>R</i>	<i>S</i>
	pairs of descriptors		
<i>R</i> , 3 → <i>l</i>	<i>S</i> , 10 → <i>l</i>	<i>R</i> , 13 → <i>l</i>	<i>S</i> , 7 → <i>l</i>
<i>R</i> , 10 → <i>u</i>	<i>S</i> , 3 → <i>u</i>	<i>R</i> , 7 → <i>u</i>	<i>S</i> , 13 → <i>u</i>
<i>R</i> , 2 → <i>l</i>	<i>S</i> , 11 → <i>u</i>	<i>R</i> , 14 → <i>u</i>	<i>S</i> , 8 → <i>l</i>
<i>R</i> , 11 → <i>l</i>	<i>S</i> , 2 → <i>u</i>	<i>R</i> , 8 → <i>u</i>	<i>S</i> , 14 → <i>l</i>
	<i>R lull</i> = <i>R luuu</i>		
	<i>S luuu</i> = <i>S lull</i>		
	A = B		

Explanation: First, the molecule is arbitrarily renumbered as above: Then, the ligands are analyzed by Sequence Rule 4b and Sequence Rule 1 is applied, leading to the specification of eight chirality centers 'C-2', 'C-3', 'C-7', 'C-8', 'C-10', 'C-11', 'C-13', 'C-14' as shown above. For the specification of the configuration at 'C-5', Sequence Rule 4b is applied in accordance with the following digraph and methodology described in P-92.5.2.1. No decision is reached because 'branch A' = 'branch B', as indicated by the result of the following analysis thus necessitating the application of Sequence Rule 5.

Ranking of ligands by Sequence Rule 5:

By application of Sequence Rule 5 using the same digraph a decision is reached after the following analysis. As in the set of highest ranked nodes both descriptors '*R*' and '*S*' are present, both of them must be used as reference descriptors.

When Sequence Rule 5, '*R*' precedes '*S*', is applied to the first sphere of descriptors (those directly bonded to N), in 'branch A' node 3 ranks higher than node 10; in 'branch B' node 13 ranks higher than node 7. At this level, no difference is noted. At the next level, where descriptors '2' and '11' and '8' and '14' are located, the highest ranking node 2 is '*R*' in 'branch A' and the highest ranking node 14 is '*S*' in 'branch B'; this is the first difference noticed permitting the ranking of 'branch A' over 'branch B'; thus the configuration '*s*' is assigned to 'C-5'.

Branch A	Branch B
3-' <i>R</i> '	13-' <i>R</i> '
10-' <i>S</i> '	7-' <i>S</i> '
2-' <i>R</i> '	14-' <i>S</i> ' (first difference encountered)
11-' <i>R</i> '	8-' <i>S</i> '
Branch A >	Branch B

P-93 CONFIGURATION SPECIFICATION

P-93.0 Introduction

P-93.1 General aspects of configuration specification

P-93.2 Tetrahedral configuration of elements other than carbon

P-93.3 Nontetrahedral configuration

P-93.4 Configuration specification of acyclic organic compounds

P-93.5 Configuration specification of cyclic organic compounds

P-93.6 Compounds composed of rings and chains

P-93.0 INTRODUCTION

Different systems are used to describe the configuration of acyclic and cyclic compounds. In Sections P-92, the various CIP stereodescriptors were described in accordance with different types of configuration. This Section describes these various systems and the selection of preferred descriptors to denote the configuration in preferred names. They are applied on the basis of the parent structures, i.e., acyclic or cyclic, along with the non-CIP stereodescriptors that are recommended for general nomenclature.

P-93.1 GENERAL ASPECTS OF CONFIGURATION SPECIFICATION

In the context of stereochemistry, the term 'configuration' is restricted to the arrangements of atoms of a molecular entity in space that distinguishes 'stereoisomers', the isomerism between which is not due to conformational differences. 'Conformation' is the spatial arrangement of the atoms affording distinction between stereoisomers which can be interconverted by rotation about formally single bonds. Configuration is discussed in this section, P-93; conformation is discussed in section P-94.

P-93.1.1 Absolute configuration

P-93.1.2 Relative configuration

P-93.1.3 Racemates

P-93.1.4 The descriptor 'ambo'

P-93.1.1 Absolute configuration

The 'absolute configuration' is the spatial arrangement of the atoms of a chiral molecular entity. It corresponds to a graphical representation and is described by stereodescriptors such as '*R*', '*S*', '*r*', '*s*', '*M*', or '*P*', as shown in Section P-92.

Examples:

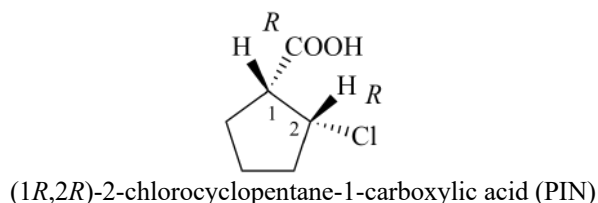
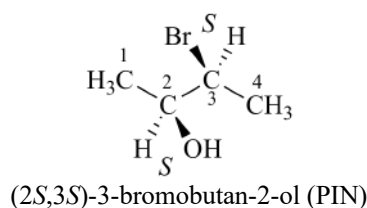
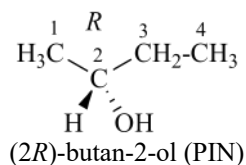

P-93.1.2 Relative configuration

P-93.1.2.1 The 'relative configuration' is the configuration of any stereogenic (asymmetric) unit with respect to any other stereogenic unit contained within the same molecular entity. Relative configuration denoting diastereoisomers may be denoted by using the prefix '*rel*' which is cited at the front of the name of one enantiomer where the configurational descriptors '*R*', '*S*', '*M*', '*P*', etc. have been used. This prefix '*rel*' with plain stereodescriptors is preferred in preferred IUPAC names to the 'starred' stereodescriptors '*R**', '*S**', '*M**', '*P**', etc. that may be used in general nomenclature. It is to be noted that the prefix '*rel*' indicates the configuration of the entire molecule. The structure of one enantiomer followed by the mention 'or enantiomer' is used to depict relative configuration. When relative configuration is described, the stereodescriptor, such as '*R*' or '*R**', is cited for the stereogenic center having the lowest locant.

Examples:

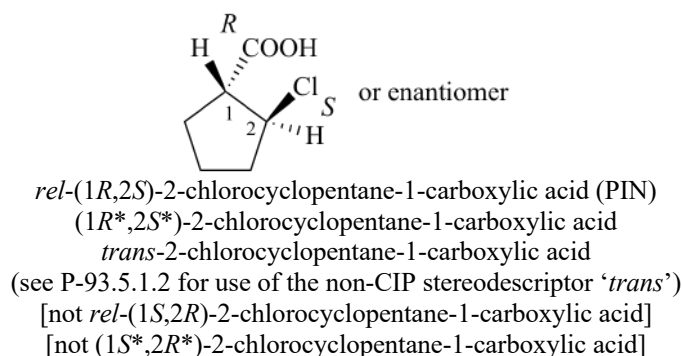

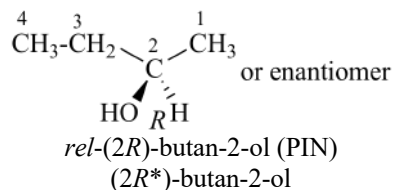
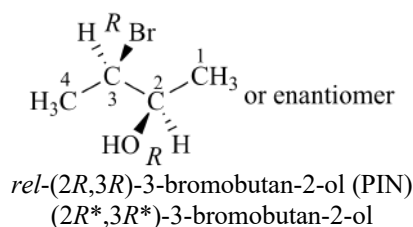

P-93.1.2.2 In compounds containing chirality centers with known absolute configurations and a stereochemically unrelated set of chirality centers with known relative configuration, the '*R*' and '*S*' descriptors must be used to designate the latter. The prefix '*rel*' cannot be used as it applies to the entire molecule.

Example:

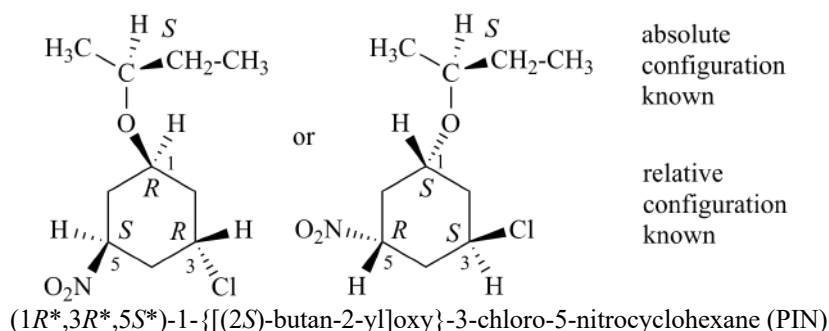

P-93.1.3 Racemates

A racemate is an equimolecular mixture of a pair of enantiomers. It does not exhibit optical activity. Racemates may be denoted by using the prefix '*rac*' cited at the front of the name of one enantiomer where the configurational descriptors '*R*', '*S*', '*M*', '*P*', etc. have been used. This prefix '*rac*' with plain stereodescriptors is preferred in preferred IUPAC names to the stereodescriptors such as '*RS*', '*SR*', etc. that may be used in general nomenclature. It is to be noted that the prefix '*rac*' indicates the configuration of the entire molecule.

The structure of one enantiomer followed by the mention 'and enantiomer' is used to depict racemates. When a racemate is described, the stereodescriptor, such as '*R*' or '*RS*', is cited for the chirality center having the lowest locant.

Examples:

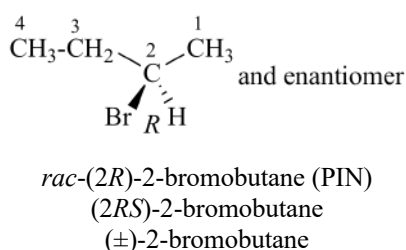
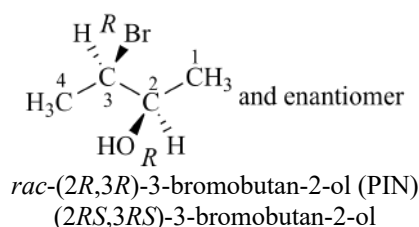
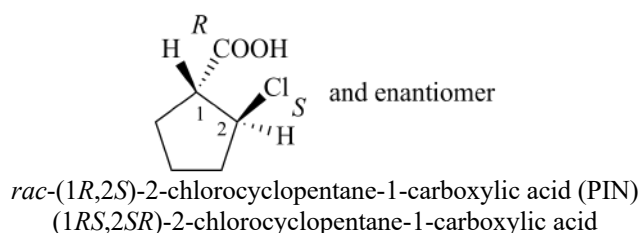

P-93.1.4 The descriptor 'ambo'

Formation of diastereoisomers by reaction at a nonstereogenic center of a chiral molecule or the reaction of a chiral compound with a racemic compound will not normally give a 50-50 mixture. To indicate this situation, the prefix 'ambo' is used (see also P-103.3.4).

Example:

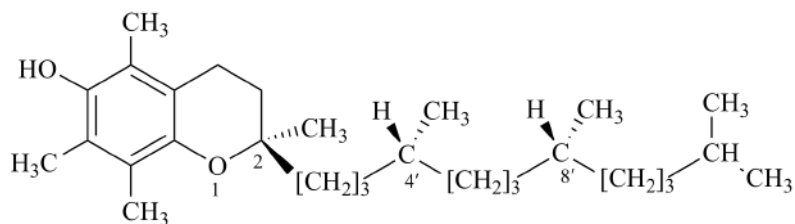

plus a proportion of the epimer at C-2

2-ambo-(2*R*,4'*R*,8'*R*)- α -tocopherol (refs. 37, 44)

2-ambo-(2*R*)-2,5,7,8-tetramethyl-2-[(4*R*,8*R*)-4,8,12-trimethyltridecyl]-3,4-dihydro-2*H*-1-benzopyran-6-ol

P-93.2 TETRAHEDRAL CONFIGURATION OF ELEMENTS OTHER THAN CARBON

P-93.2.0 Introduction

P-93.2.1 General methodology

P-93.2.2 Azanium (ammonium) and phosphanium (phosphonium) compounds

P-93.2.3 Amine oxides and phosphane oxides

P-93.2.4 Phosphates, phosphonates, and related compounds

P-93.2.5 Sulfates, sulfonates, and related compounds

P-93.2.6 Compounds of Group 14 (other than carbon compounds)

P-93.2.0 Introduction

The CIP priority system described for stereogenic carbon centers is extended to any atom having four ligands tetrahedrally arranged. Many examples are illustrated in this section.

P-93.2.1 General methodology

The absolute configuration of any chirality center with four ligands tetrahedrally arranged is described by '*R*' and '*S*' stereodescriptors; the absolute configuration of pseudoasymmetric centers is described by '*r*' and '*s*'. The assignment of these descriptors is the same as for carbon compounds. Numerical locants are used before stereodescriptors, but letter locants such as '*N*', '*O*' or '*S*' are not. To avoid uncertainty in preferred IUPAC names, in the absence of any reference locant in the name, the name of the compound containing the stereogenic unit whose central atom is B, S, Se, Te, N, P, As, Sb, Bi is written within appropriate nesting marks. In general nomenclature, locants and specific nesting can be omitted.

P-93.2.2 Azanium (ammonium) and phosphanium (phosphonium) compounds

The four different ligands are considered in priority order 'a' > 'b' > 'c' > 'd' in the manner described in P-92.2. Stereodescriptors are cited as indicated in P-91.2.

Examples:

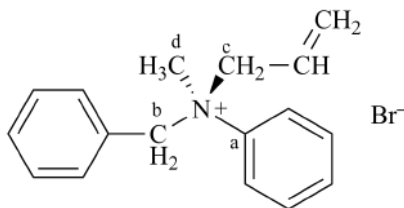

(*R*)-*N*-benzyl-*N*-methyl-*N*-(prop-2-en-1-yl)anilinium bromide (PIN)

(*R*)-*N*-benzyl-*N*-methyl-*N*-(prop-2-en-1-yl)benzenaminium bromide

(*R*)-benzyl(methyl)(phenyl)(prop-2-en-1-yl)azanium bromide

(*R*)-benzyl(methyl)(phenyl)(prop-2-en-1-yl)ammonium bromide

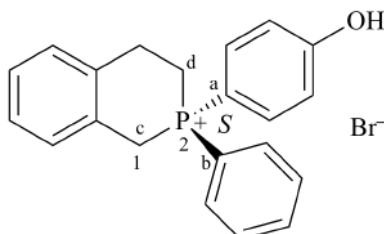

(2*S*)-2-(4-hydroxyphenyl)-2-phenyl-1,2,3,4-tetrahydroisophosphinolin-2-ium bromide (PIN)

Arsanium, stibanium, and bismuthanium salts are treated in the same manner as phosphorus centered cations.

P-93.2.3 Amine oxides and phosphane oxides

With chiral amine oxides and phosphane oxides the oxygen atom is treated as the fourth atom. The nature of the bonding to this oxygen atom is not relevant.

Examples:

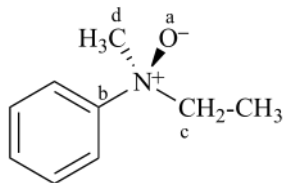

(*S*)-*N*-ethyl-*N*-methylaniline *N*-oxide (PIN; see P-74.2.1.2)
 (*S*)-[ethyl(methylbenzenaminiumyl)]oxidanide
 [(*S*)-ethyl(methyl)(phenyl)azaniumyl]oxidanide

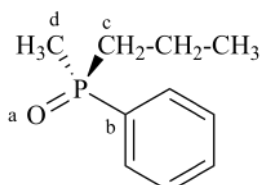

(*S*)-methyl(phenyl)(propyl)- λ^5 -phosphanone (PIN; see P-74.2.1.4)
 (*S*)-methyl(phenyl)(propyl)phosphane oxide

P-93.2.4 Phosphates, phosphonates, and related compounds

The 'P=O' bond, as conventionally written in phosphates, phosphonates and related compounds, is considered as a single bond, as there are already four atoms or groups in the tetrahedral configuration. Similarly, the formal arrangement of charges is not considered when determining the configuration of a chiral molecule. As the stereodescriptors '*R*' and '*S*' describe the entire structure, either a salt or an ester, the full name is placed in parentheses to denote the global configuration.

Examples:

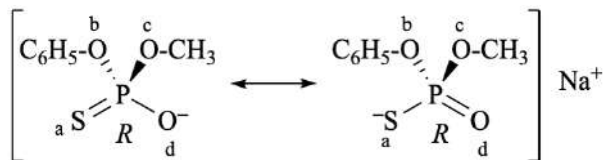

sodium (*R*)-(O-methyl O-phenyl phosphorothioate) (PIN)

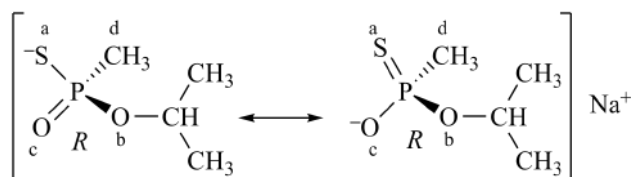

sodium (*R*)-(O-propan-2-yl methylphosphonothioate) (PIN)
 sodium (*R*)-[O-(1-methylethyl) methylphosphonothioate]

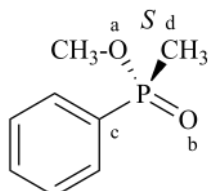

methyl (*S*)-[methyl(phenyl)phosphinate] (PIN)

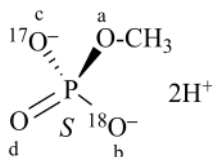

dihydrogen (*S*)-[O-methyl ($^{17}\text{O}_1, ^{18}\text{O}_1$)phosphate] (PIN)

P-93.2.5 Sulfates, sulfonates, and related compounds

Sulfates, sulfonates and related anions are treated in the same way as phosphate anions (see P-93.2.4). Selenates, selenonates, tellurates, telluronates and related compounds are treated like sulfates, sulfonates and related compounds. Sulfoxides are discussed in P-93.3.3.2.

Examples:

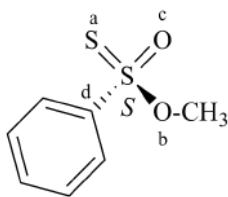

O-methyl (*S*)-(benzenesulfonylthioate) (PIN)

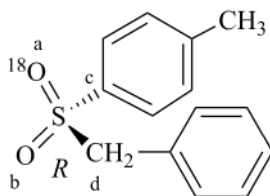

1-methyl-4-[(*R*)-phenyl(¹⁸O₁)methanesulfonyl]benzene (PIN)

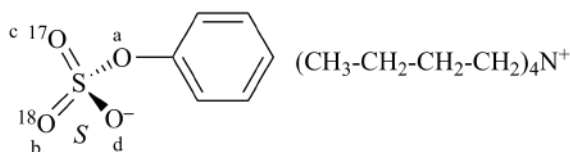

N,N,N-tributylbutan-1-aminium (*S*)-[*O*-phenyl (¹⁷O₁,¹⁸O₁)sulfate] (PIN; see also P-83.1.2.2)
 tetrabutylammonium (*S*)-[*O*-phenyl (¹⁷O₁,¹⁸O₁)sulfate]
 tetrabutylazanium (*S*)-[*O*-phenyl (¹⁷O₁,¹⁸O₁)sulfate]

P-93.2.6 Compounds of Group 14 (other than carbon compounds)

Chiral silanes, germanes, stannanes, and plumbanes are treated in the same way as carbon compounds.

Example:

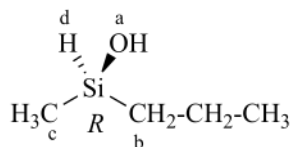

(*R*)-methyl(propyl)silanol (PIN)

P-93.3 NONTETRAHEDRAL CONFIGURATION

P-93.3.1 General methodology

P-93.3.2 Polyhedral symbols

P-93.3.3 Configuration index and priority number

P-93.3.4 Chirality symbols

P-93.3.1 General methodology

When an atom is attached to three, four, five, or six ligands (atoms or groups) a number of geometrical configurations are possible. In general, there will be some distortion from the idealized geometry of the regular solid due to differences between the atoms involved. Thus with five attached ligands they may be arranged as a trigonal bipyramid or square pyramid and with six as an octahedron or trigonal prism (which is much less common). The notation described below for these systems is described in the IUPAC rules for inorganic coordination nomenclature (IR-9.3, ref. 12). Details of the geometry of systems with a coordination greater than six will also be found in ref. 12.

Stereodescriptors for nontetrahedral configurations are composed of three parts.

- (1) A symbol indicating overall geometry called the 'polyhedral symbol';
- (2) A symbol called the 'configuration index' that describes the configuration of ligands around the central atom;
- (3) A symbol indicating the 'absolute configuration' associated with the central atom called the 'chirality symbol'.

The three parts of the stereodescriptor are enclosed in parentheses and separated from each other by hyphens and cited at the front of the name separated from it by a hyphen.

P-93.3.2 Polyhedral symbols

The polyhedral symbol takes the form of an abbreviation of the name of the closest idealized geometry (italic upper case letters) and a number indicating how many ligands are attached (see Rule IR-9.3.2.1, ref. 12). Table 9.1 gives the symbols for the most frequently encountered polyhedra related to structures of organic compounds. The configuration of molecules containing a tetrahedral center has been discussed above in Section P-92.

The abbreviation for the idealized polyhedron and the number of attached atoms or groups are separated by a hyphen and enclosed in parentheses in front of the name of the compound, if no further information is required.

Table 9.1 Commonly encountered polyhedral symbols in organic compounds

Idealized geometry	Attached atoms or groups	Polyhedral symbol
trigonal pyramid	3	<i>TPY-3</i>
T-shape	3	<i>TS-3</i> (ref. 12)
tetrahedron	4	<i>T-4</i>
square planar	4	<i>SP-4</i>
see-saw	4	<i>SS-4</i> (ref. 12)
trigonal bipyramid	5	<i>TBPY-5</i>
square pyramid	5	<i>SPY-5</i>
octahedron	6	<i>OC-6</i>



TPY-3



TS-3

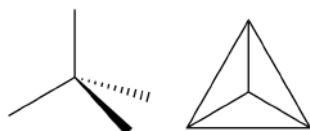

T-4

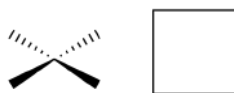

SP-4

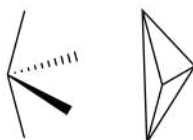

SS-4

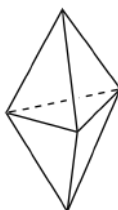

TBPY-5

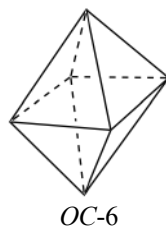
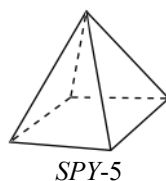

Examples:

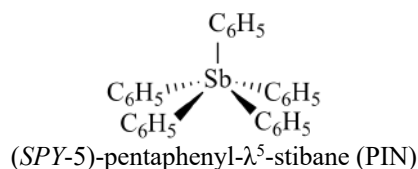
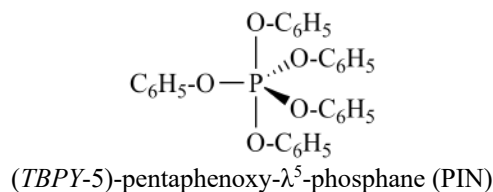

P-93.3.3 Configuration index and priority rules

- P-93.3.3.1 General methodology
- P-93.3.3.2 Trigonal pyramid
- P-93.3.3.3 T-shape systems
- P-93.3.3.4 See-saw systems
- P-93.3.3.5 Trigonal bipyramid
- P-93.3.3.6 Square pyramid
- P-93.3.3.7 Octahedron

P-93.3.3.1 General methodology

The configuration index is a series of numbers to identify where each atom or group is located (see Rule IR-9.3.3.2, ref. 12). It is based on the CIP priority order (see P-92) of the atoms attached. The atom or atoms with highest priority are given priority number one '1'; the next priority number two '2', and so on. In the examples below, structures are denoted by locants. They are also denoted by circled numbers that are the priority numbers used in the application of the CIP system. In addition to the standard CIP Sequence Rules **1** and **2**, three additional rules are needed:

(a) The 'trans-maximum-difference' of priority (see IR-9.3.3.3, ref. 12). Between atoms with the same priority number, high priority is assigned to the atom which is *trans* (opposite) to the atom having the lowest priority number. In the following planar structure, 'a and c' (and 'b and d') are 'trans':

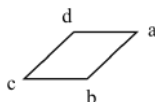

(b) The priming convention (see IR-9.3.5.3, ref. 12). When there are two (or three) identical rings present, the priority numbers of one of them are primed (and the third double primed).

(c) Unprimed priority numbers are preferred to primed priority numbers. In coordination nomenclature rings are di- and polydentate ligands.

Each idealized geometry has its own rules for assignment of the configuration index.

P-93.3.3.2 Trigonal pyramid

The configuration of molecules containing a trigonal pyramidal center (TPY-3) is described in a similar way to that of tetrahedral centers (T-4) described above in P-92 (see IR-9.3.4.3, ref. 12). The tetrahedral configuration is achieved by adding a phantom atom (0) to the central atom perpendicular to the base of the pyramid. No configuration index is used with the 'TPY-3' symbol. Priority numbers are '1 > 2 > 3 > 4'.

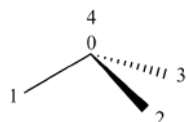
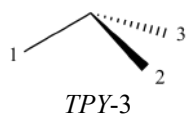

(T-4) (a phantom atom '0' is shown)

Traditionally, sulfoxides have been considered as a tetrahedral system composed of a central atom, ligands, and a lone pair of electrons (or phantom atom). No polyhedral symbol is used.

Example:

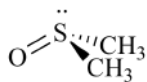

(methanesulfinyl)methane (PIN)

[not (T-4)-(methanesulfinyl)methane;

the symbol (T-4) is not used in the names of organic compounds]

P-93.3.3.3 T-shape systems

The configuration index of the T-shape configuration

n follows the polyhedral symbol, *TS*-3, and consist of a single digit, the priority number of the atom or substituent group on the stem of the 'T' (as opposed to the cross piece of the 'T') (see IR-9.3.3.7, ref. 12).

Example:

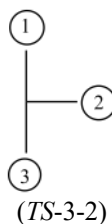

Example:

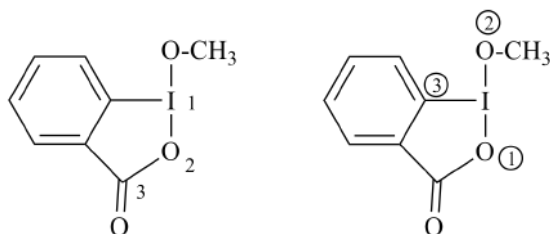

(*TS*-3-3)-1-methoxy-1 λ^3 ,2-benziodoxol-3(1*H*)-one (PIN)

[not (*TBPY*-3)-1-methoxy-1 λ^3 ,2-benziodoxol-3(1*H*)-one; see P-93.3.3.5.1]

P-93.3.3.4 See-saw systems

The configuration index of a see-saw system consists of the priority numbers indicating the two atoms or groups separated by the largest angle (see IR-9.3.3.8, ref. 12).

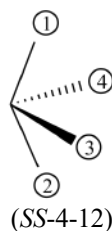

Example:

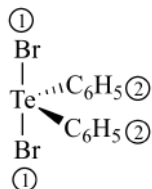

(*SS*-4-11)-dibromodiphenyl- λ^4 -tellurane (PIN)
[not *TBPY*-4-dibromodiphenyl- λ^4 -tellurane (see P-93.3.3.5.1)]

P-93.3.3.5 Trigonal bipyramid

P-93.3.3.5.1 The configuration index of a trigonal bipyramid (see Rule IR-9.3.3.6, ref 12) consists of the priority numbers of the two apical atoms (lower number first if different), representing the reference axis of the system. Priority numbers are: '1 > 2 > 3 > 4 > 5'.

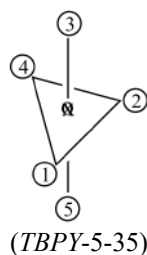

The polyhedral symbol and configuration index, separated by a hyphen, are enclosed in parentheses and placed at the front of the name of the compound, if no further information is required.

Example:

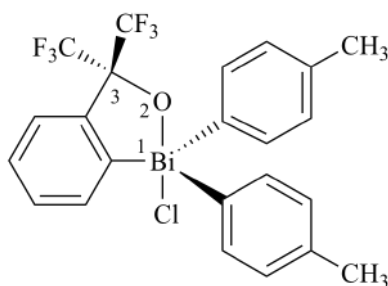

(*TBPY*-5-12)-1-chloro-1,1-bis(4-methylphenyl)-3,3-bis(trifluoromethyl)-1,3-dihydro-2,1 λ^5 -benzoxabismole (PIN)

Explanation:

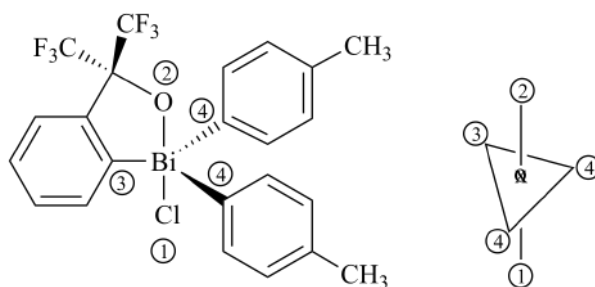

P-93.3.3.5.2 The trigonal bipyramid system has been extended to central atoms substituted by four ligands and one lone pair of electrons, and by three ligands and two lone pairs of electrons (see SP-9.2, ref. 8).

When one lone pair is present, the polyhedral symbol is '*TBPY*-4'; the symbol is '*TBPY*-3' when two lone pairs of electrons are present. This system is no longer recommended. Instead, in preferred IUPAC names, the polyhedral symbol '*SS*' is used in place of '*TBPY*-4' for see-saw systems (see P-93.3.3.4); similarly the symbol '*TS*-3' is used in place of '*TBPY*-3' for T-shape systems (see P-93.3.3.3).

P-93.3.3.6 Square pyramid

The configuration index of a square pyramid (see Rule IR-9.3.3.5, ref. 12) is given by two numbers. The first is the priority number of the apical atom and the second is the priority number of the atom *trans* (opposite) with reference to the atom having the highest priority (lowest priority number) in the base of the pyramid. If necessary, the rule of the '*trans*-maximum difference of priority numbers' is applied (see Rule IR- 9.3.3.3, ref. 12). The reference axis corresponds to the bond to the apical ligand. The polyhedral symbol and configuration index, separated by a hyphen, are enclosed in parentheses and cited in front of the name of the compound, if no further information is required. For the ranking order '1 > 2 > 3 > 4 > 5', the following configuration is denoted by the configuration index '14'.

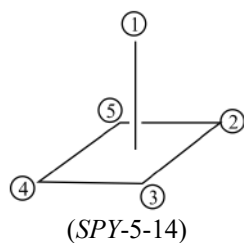

Example 1:

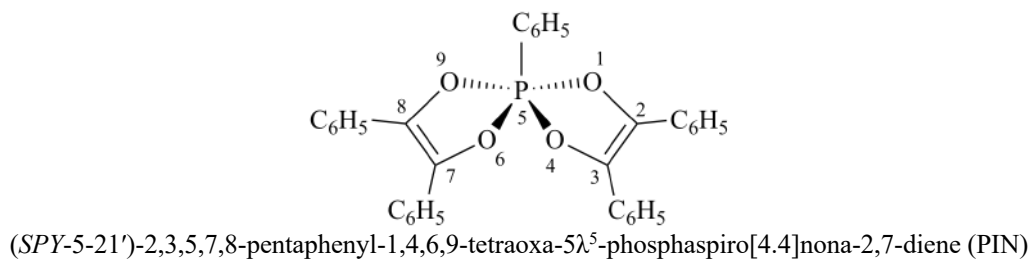

Explanation:

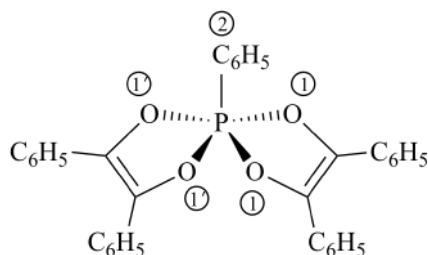

Example 2:

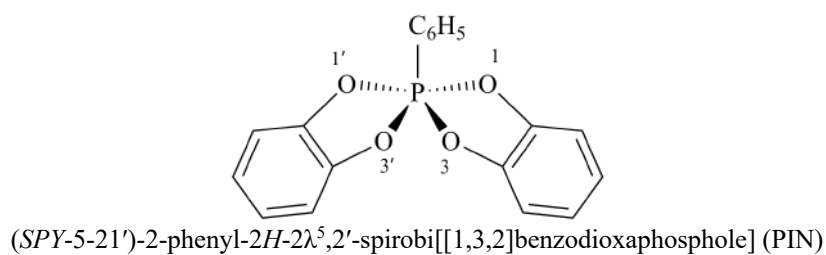

Explanation:

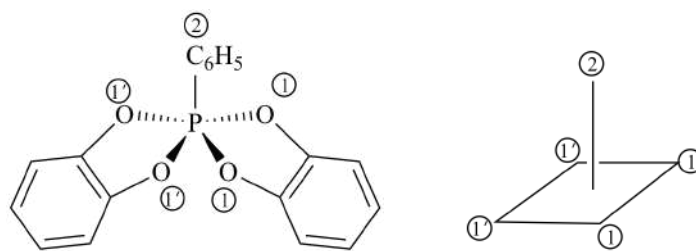

Example 3:

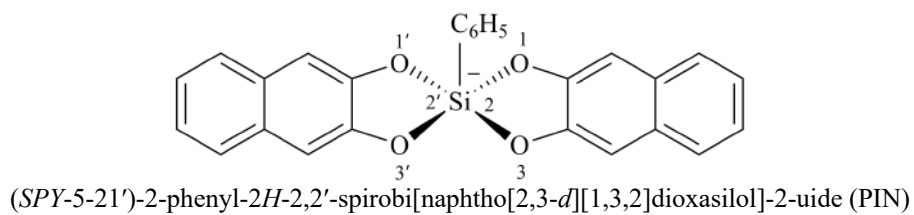

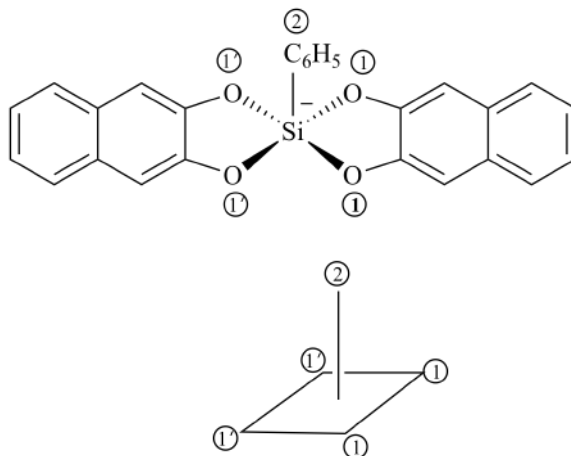
Explanation:**P-93.3.3.7 Octahedron**

The configuration index of an octahedron (see Rule IR-9.3.3.4, ref. 12) is given by two numbers. The first is the priority number of the atom *trans* (opposite) to the atom of highest priority (lowest priority number). This defines the reference axis. The second number is the priority number of the atom *trans* (opposite) the atom of highest priority (lowest priority number) in the plane perpendicular to the reference axis. If necessary, the principle of the *trans*-maximum-difference' of priority numbers is applied. The polyhedral symbol and configuration index, separated by a hyphen, are enclosed in parentheses and cited in front of the name of the compound, if no further information is needed. For the order of priority '1 > 2 > 3 > 4 > 5 > 6', the configuration index is '25', as illustrated below.

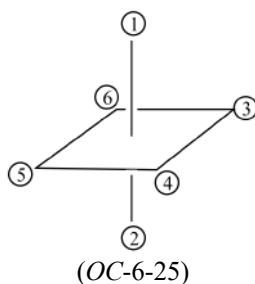
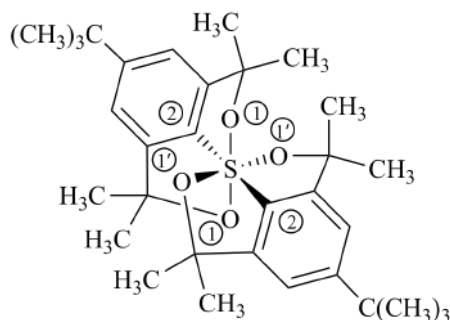
**Example:**

(OC-6-11')-4,4'-di-*tert*-butyl-2,2,2',2',6,6,6,6'-octamethyl-2*H*,2'*H*,6*H*,6'*H*-8λ⁶,8'-spirobi[[1,2]oxathiole[4,3,2-*hi*][2,1]benzoxathiole] (PIN)

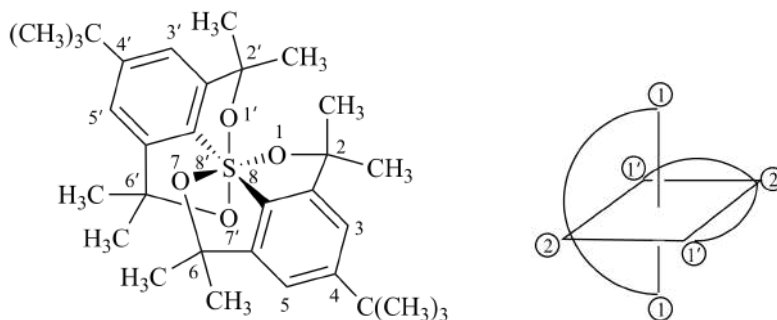
Explanation:**P-93.3.4 Chirality symbols**

The chirality symbols 'A' and 'C' are used to indicate the absolute configuration of compounds described by a polyhedral symbol and a configuration index, with the exception of trigonal pyramidal polyhedra that are described by 'R' and 'S' stereodescriptors (see P-93.3.4.1) and tetrahedral configuration that is described in P-92.1.1.

P-93.3.4.1 The chirality symbols 'R/S'.

The stereodescriptors 'R' and 'S' (as defined in P-92.2) are used to indicate the absolute configuration of a trigonal pyramidal system discussed in P-93.3.3.2 (see Rule IR-9.3.4.3, ref. 12). A phantom atom of low priority, and not a pair of electrons, is used to create the tetrahedral configuration permitting the use of 'R/S' stereodescriptors in the manner described for tetrahedral stereogenic centers.

Examples:

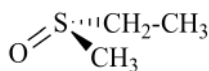

(S)-(methanesulfinyl)ethane (PIN)

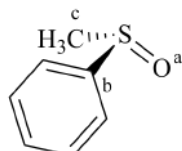

(S)-(methanesulfinyl)benzene (PIN)

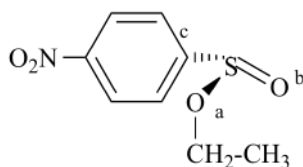

ethyl (R)-4-nitrobenzene-1-sulfinate (PIN)

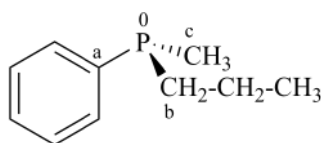

(R)-methyl(phenyl)(propyl)phosphane (PIN)
(a phantom atom, '0', is shown on the phosphorus atom)

P-93.3.4.2 The chirality symbols 'A' and 'C'

P-93.3.4.2.1 The atoms in the plane perpendicular to the reference axis are viewed from the side with the atom or group of highest priority (lowest priority number) on the reference axis. If the direction from the atom in this plane with highest priority (lowest priority number) to the atom with the next higher priority is clockwise the chirality symbol is 'C', if anticlockwise 'A'. The term 'anticlockwise' is also called 'counterclockwise'. The polyhedral symbol, configuration index, and chirality symbol, each separated by a hyphen, are enclosed in parentheses and cited in front of the name of the compound (see Rule IR-9.3.4.4, ref. 12). The order of priority '1 > 2 > 3 > 4 > 5 > 6' for the trigonal bipyramid, the square pyramid, and the octahedral configurations are illustrated below:

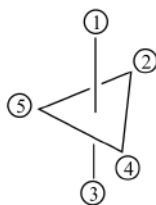

TBPY-5-13-C

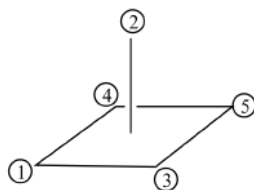

SPY-5-25-A

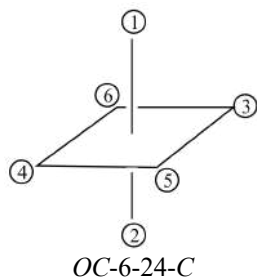

Example 1:

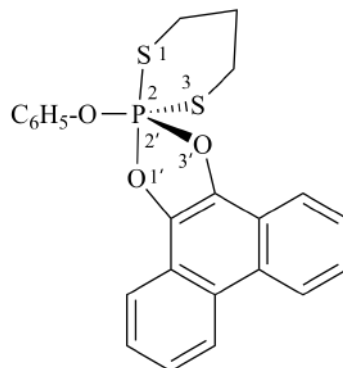

(TBPY-5-12-C)-2-phenoxy-2H-2λ⁵-spiro[[1,3,2]dithiaphosphinane-2,2'-phenanthro[9,10-*d*][1,3,2]dioxaphosphole]
(PIN)

Explanation:

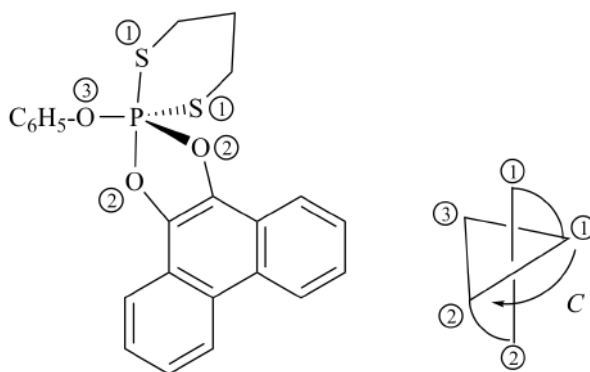

Example 2:

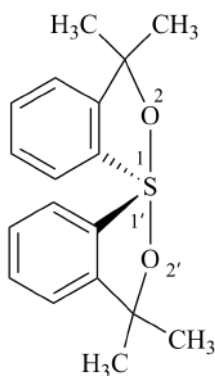

(SS-4-11'-A)-3,3,3',3'-tetramethyl-3H,3'H-1λ⁴,1'-spirobi[[2,1]benzoxathiole] (PIN)
[not (TBPY-4-11'-A)-3,3,3',3'-tetramethyl-3H,3'H-1λ⁴,1'-spirobi[[2,1]benzoxathiole]]

Explanation:

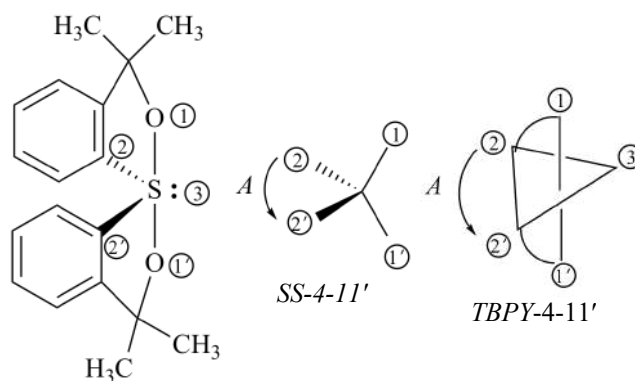

Example 3:

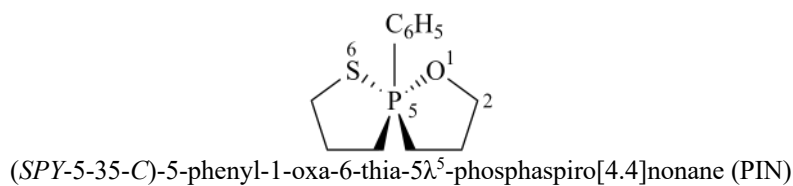

Explanation:

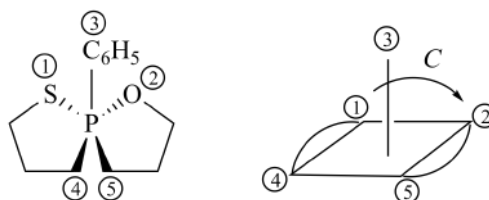

Example 4:

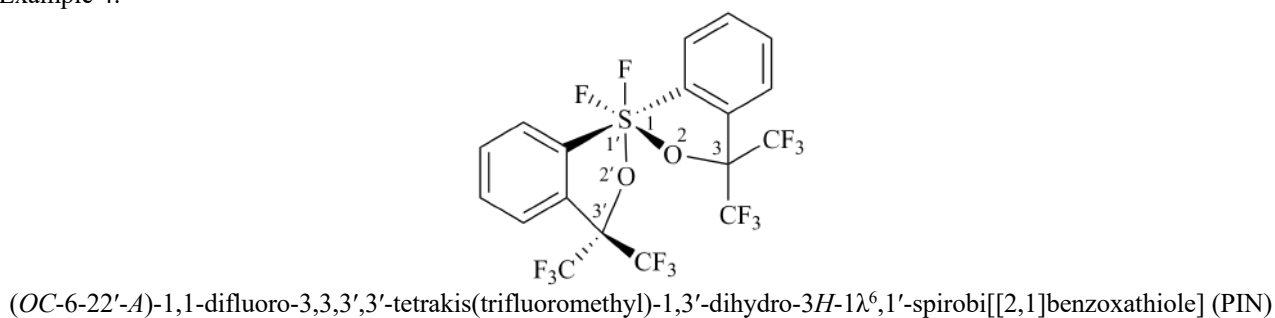

Explanation:

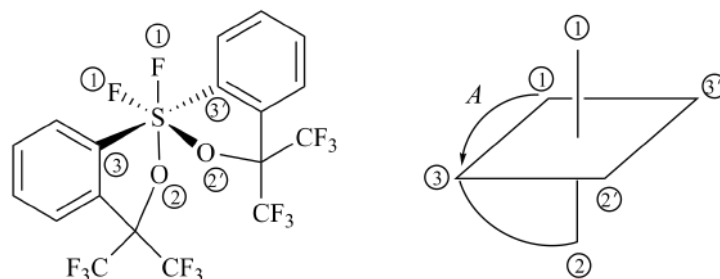

P-93.3.4.2.2 When necessary, the locant of the chirality center is included in front of the polyhedral descriptor, and other chirality centers are specified in accordance with the increasing value of locants as indicated in P-91.3; brackets enclose the complete descriptor denoting the overall geometry of the molecule.

Example:

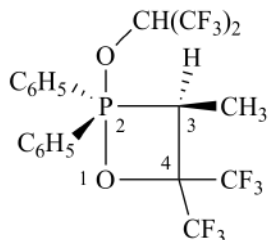

[2(*TBPY*-5-12),3*S*]-2-[(1,1,1,3,3,3-hexafluoropropan-2-yl)oxy]-3-methyl-2,2-diphenyl-4,4-bis(trifluoromethyl)-1,2λ⁵-oxaphosphetane (PIN)

Explanation:

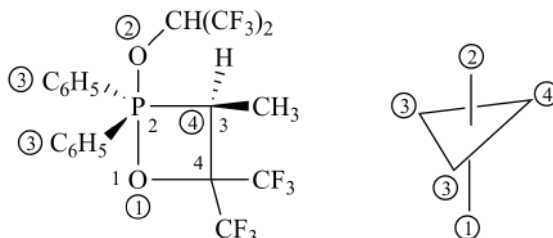

P-93.4 CONFIGURATION SPECIFICATION OF ACYCLIC ORGANIC COMPOUNDS

This section illustrates the CIP priority system as the preferred system of specification of configuration and describes other systems that are used in substitutive nomenclature. Preferred names are formed in accordance with the principles, rules, and convention described in Chapters P-1 through P-8. Numbering of compounds is established by applying rules described in P-14.4, especially when the final choice depends on the presence of stereodescriptors. Stereodescriptors are added to the names as indicated in P-91.3.

P-93.4.1 Specification of stereogenic centers

P-93.4.2 Specification of configuration for double bonds

P-93.4.1 Specification of stereogenic centers

P-93.4.1.1 The presence of one stereogenic center is denoted by the stereodescriptors '*R*' and '*S*', as described in P-92.2. Stereodescriptors are preceded by a locant when the stereogenic center needs to be described by a locant. When no locant is required in the name of the chiral compound, no locant is necessary before the stereodescriptor. The symbol (\pm), (+) or (–) may be used in general nomenclature.

Examples:

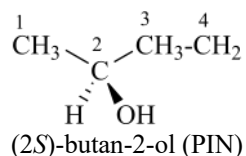
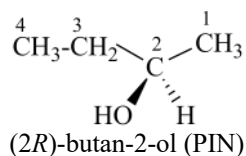

When required, either Sequence Rule 1 alone or both Sequence Rules 1 and 2 are applied to specify the configuration of isotopically modified compounds as illustrated below (see also P-92.3). When inserted into the name at the same place as isotopic descriptors, the stereochemical affixes are cited first.

Examples:

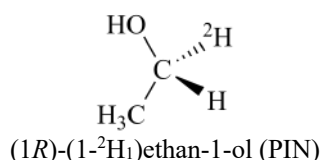
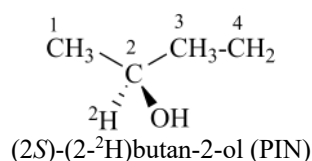

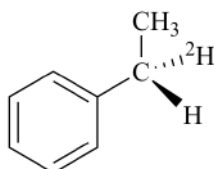

[(1*S*)-(1-²H₁)ethyl]benzene (PIN)

P-93.4.1.2 When, in a parent structure, two or more stereodescriptors, '*R*' and/or '*S*', are required to describe a single structure, they are placed at the front of the name, enclosed in parentheses followed by a hyphen, and cited according to the ascending order of their corresponding locants, regardless of the kind of descriptor. Many examples are given in Chapter P-10 to specify the configuration of carbohydrates (see P-102.5.2.3), amino acids peptides (see P-103.1.3), and lipids (see P-107.4.3). Examples given in this Section are intended to illustrate the use of stereodescriptors for pseudoasymmetric stereogenic units and the treatment of nonstereogenic units.

Examples:

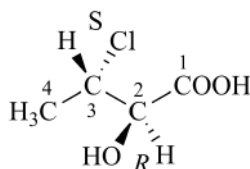

(2*R*,3*S*)-3-chloro-2-hydroxybutanoic acid (PIN)

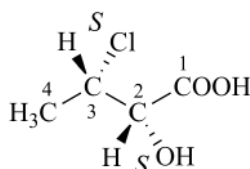

(2*S*,3*S*)-3-chloro-2-hydroxybutanoic acid (PIN)

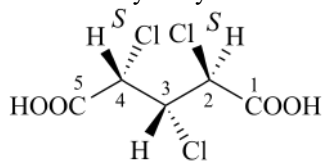

(2*S*,4*S*)-2,3,4-trichloropentanedioic acid (PIN)

(the nonstereogenic carbon atom 'C-3' is not identified by a stereodescriptor)

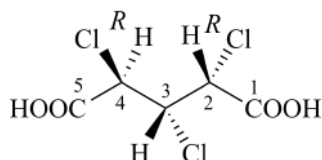

(2*R*,4*R*)-2,3,4-trichloropentanedioic acid (PIN)

(the nonstereogenic carbon atom 'C-3' is not identified by a stereodescriptor)

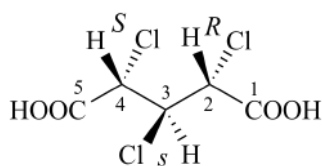

(2*R*,3*s*,4*S*)-2,3,4-trichloropentanedioic acid (PIN)

[chirality center '*R*' receives the lowest locant [see P-14.4 (j)];

application of Sequence Rule 5 generates the stereodescriptor '*s*' at 'C-3']

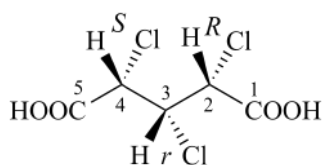

(2*R*,3*r*,4*S*)-2,3,4-trichloropentanedioic acid (PIN)

[chirality center '*R*' receives the lowest locant [see P-14.4 (j)];

application of Sequence Rule 5 generates stereodescriptor '*r*' at 'C-3']

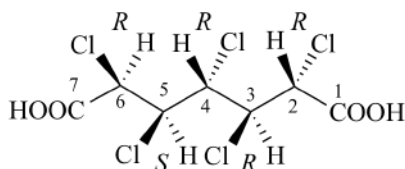

(2*R*,3*R*,4*R*,5*S*,6*R*)-2,3,4,5,6-pentachloroheptanedioic acid (PIN)
[application of Sequence Rule 4 ('*RR*' > '*SR*') generates stereodescriptor '*R*' at C-4]

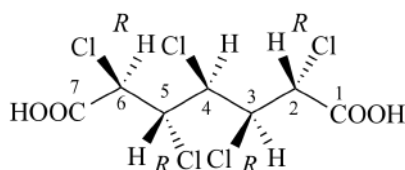

(2*R*,3*R*,5*R*,6*R*)-2,3,4,5,6-pentachloroheptanedioic acid (PIN)
(the carbon atom at C-4 is a nonstereogenic unit)

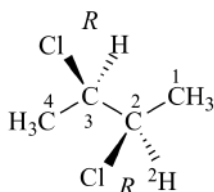

(2*R*,3*R*)-2,3-dichloro-(2-²H)butane (PIN)

P-93.4.1.3 Stereodescriptors, if any, denoting the absolute configuration of a component cited as a prefix or in functional class names, are cited immediately before each respective component.

Examples:

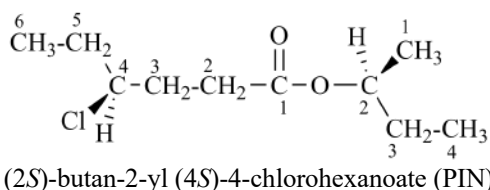

(2*S*)-butan-2-yl (4*S*)-4-chlorohexanoate (PIN)

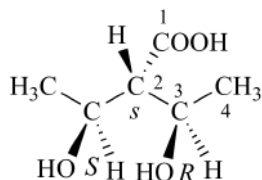

(2*s*,3*R*)-3-hydroxy-2-[(1*S*)-1-hydroxyethyl]butanoic acid (PIN)

Explanation. Four steps are used in the construction of the stereospecific name:

Step 1: configurations '*R*' and '*S*' are assigned to the hydroxylated stereogenic centers;

Step 2: configuration '*s*' is assigned to the pseudoasymmetric stereogenic center;

Step 3: the principal chain has the maximum number of stereogenic centers having the '*R*' configuration (see P-45.6.3);

Step 4: the name is constructed by citing the stereodescriptors at the front of the principal chain and of the substituent.

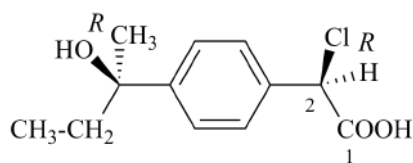

(2*R*)-2-chloro-2-{4-[(2*R*)-2-hydroxybutan-2-yl]phenyl}acetic acid (PIN)

P-93.4.2 Specification of configuration for double bonds

P-93.4.2.1 Specification of the configuration of double bonds

P-93.4.2.2 Allenes and cumulenes having an even number of double bonds

P-93.4.2.3 Cumulenes having an odd number of double bonds

P-93.4.2.4 Specification of configuration in unsaturated compounds containing multiple stereogenic units

P-93.4.2.1 Specification of the configuration of double bonds

P-93.4.2.1.1 Stereodescriptors 'Z' and 'E', and 'cis' and 'trans'

The stereodescriptors 'Z' and 'E' have been defined in section P-92.4; they are recommended to specify the configuration of double bonds as preferred stereodescriptors in preferred IUPAC names. Their use in nomenclature is described here. They have replaced the stereodescriptors 'cis' and 'trans' that are still recommended for general nomenclature and in the nomenclature of carotenoids.

The stereodescriptors 'cis' and 'trans' are used in general nomenclature only to describe double bonds having two hydrogen atoms, one on each carbon atom. Locants corresponding to those needed to describe a double bond are used before the stereodescriptors 'E' and 'Z', but not before 'cis' and 'trans'. Locants are cited at the front of the stereodescriptor, followed by a hyphen; parentheses are used to nest the entire stereodescriptor.

Examples:

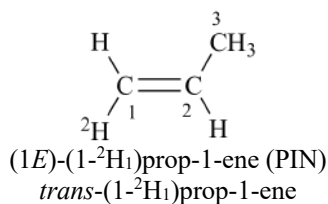
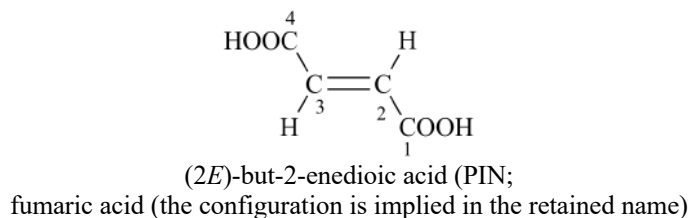
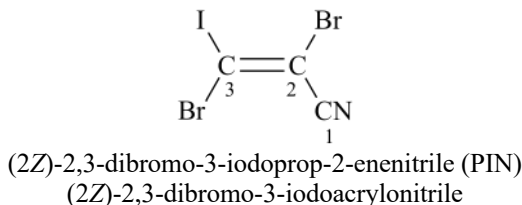
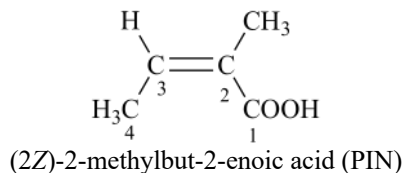
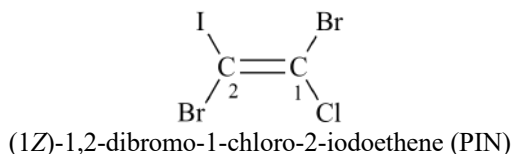
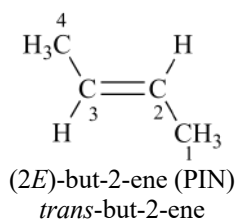
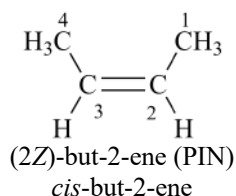

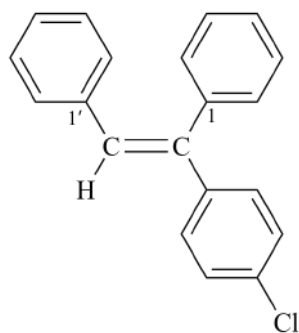

1,1'-[(1*E*)-1-(4-chlorophenyl)ethene-1,2-diyl]dibenzene (PIN, see P-93.6)
4-chloro-1,1'-[(1*E*)-1-phenylethene-1,2-diyl]dibenzene

P-93.4.2.1.2 Compounds containing more than one double bond

The stereodescriptors '*E*' and '*Z*' related to the parent are cited, preceded by the appropriate locant if more than one double bond is present, before the complete name of the compound, or before the name of the appropriate component. Chain locants are used when double bonds are '*exo*' to the chain (see fifth example below). If more than one descriptor is used, the descriptors are cited in ascending order of their respective locants.

When alternative numberings of a chain or rings or ring systems are possible, that numbering is chosen which gives a '*cis*' attachment at the first point of difference. Attention must be given to the fact that a '*cis*' attachment is denoted by the stereodescriptor '*Z*'.

Stereodescriptors '*cis*' and '*trans*' may be used to describe double bonds having two hydrogen atoms, one on each carbon atom, but stereodescriptors '*E*' and '*Z*' are used in preferred IUPAC names. The stereodescriptors '*cis*' and '*trans*' are cited at the front of the name, preceded by the appropriate locant, if necessary, followed by a hyphen.

Examples:

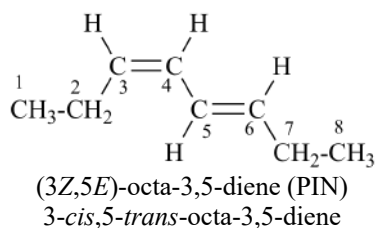
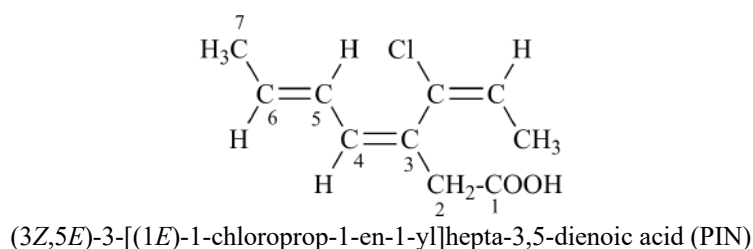
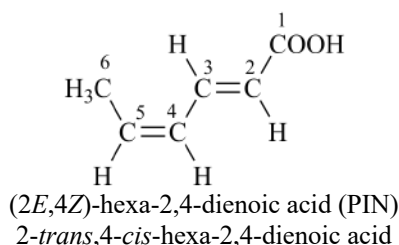
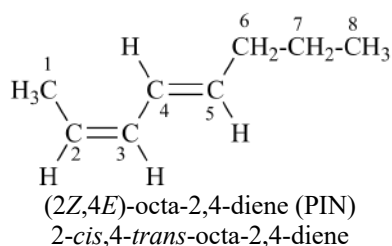

[the double bond with the *cis* configuration receives the lowest locants [see P-14.4 (j)]]

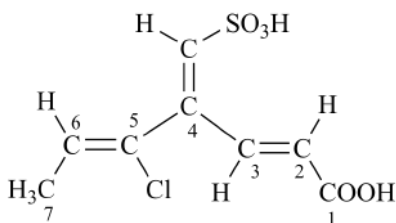

(2*E*,4*E*,5*Z*)-5-chloro-4-(sulfomethylidene)hepta-2,5-dienoic acid (PIN)

P-93.4.2.1.3 Descriptors ‘*E*’ and ‘*Z*’ to denote double bonds linked to heteroatoms

The stereodescriptors ‘*E*’ and ‘*Z*’ are also used to indicate the configuration of double bonds involving atoms other than carbon. A lone pair of electrons, when present, is considered to have the atomic number ‘0’ (zero). The descriptors ‘*syn*’ and ‘*anti*’, and ‘*cis*’ and ‘*trans*’, are no longer recommended for these situations. No locant is required before the stereodescriptor when none is present in a name, but the stereodescriptor is placed in parentheses as indicated in P-91.3.

Examples:

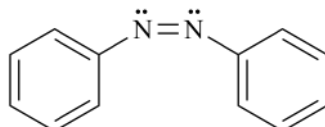

(*Z*)-diphenyldiazene (PIN)
(not *cis*-diphenyldiazene)

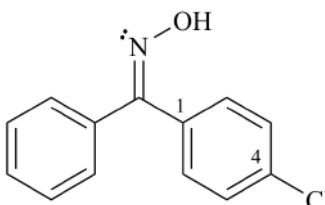

(*Z*)-*N*-hydroxy(4-chlorophenyl)(phenyl)methanimine (PIN)
(*Z*)-*N*-[(4-chlorophenyl)(phenyl)methylidene]hydroxylamine
(*Z*)-(4-chlorophenyl)(phenyl)methanone oxime

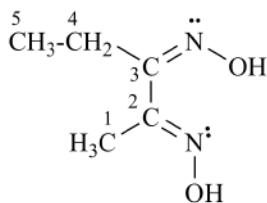

(2*E*,3*Z*)-*N*²,*N*³-dihydropentane-2,3-diimine (PIN)
(2*E*,3*Z*)-(pentane-2,3-diylidene)bis(hydroxylamine)
(2*E*,3*Z*)-pentane-2,3-dione dioxime

P-93.4.2.2 Allenes and cumulenes having an even number of double bonds

When appropriately substituted, allenes are chiral compounds having an axis of chirality. Chirality is thus described by the stereodescriptors ‘*R_a*’ and ‘*S_a*’ or ‘*M*’ and ‘*P*’, as described in P-92.1.2.1.2 and P-92.1.2.2.1, respectively. Stereodescriptors ‘*M*’ and ‘*P*’ are preferred to ‘*R_a*’ and ‘*S_a*’ in preferred IUPAC names. The stereodescriptor ‘*M*’ or ‘*P*’, describing the cumulene system, is preceded by a locant indicating the starting point of the cumulated double bond system having consecutive increasing locants differing by one unit. Compound locants are used only when locants are not consecutive as shown in P-93.5.2.3.

Examples:

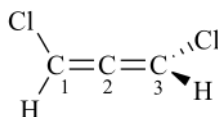

(1*M*)-1,3-dichloropropa-1,2-diene (PIN)
(1*R_a*)-1,3-dichloropropa-1,2-diene

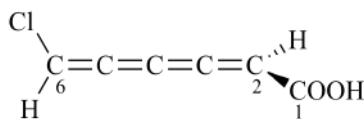

(2*P*)-6-chlorohexa-2,3,4,5-tetraenoic acid (PIN)
(2*S_a*)-6-chlorohexa-2,3,4,5-tetraenoic acid

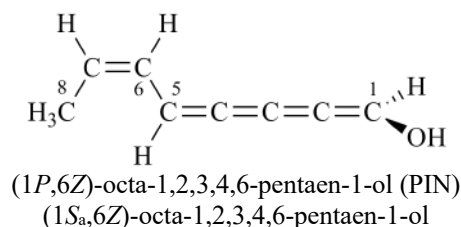

P-93.4.2.3 Cumulenes having an odd number of double bonds

Cumulenes having an odd number of double bonds are planar molecules, like double bonds. The preferred stereodescriptors are '*E*' and '*Z*'. Stereodescriptors '*cis*' and '*trans*' may be used in general nomenclature.

The stereodescriptor '*E*' or '*Z*', describing the cumulene system, is preceded by a locant indicating the starting point of the cumulated double bond system having consecutive increasing locants differing by one unit. Compound locants are used only when locants are not consecutive as shown in P-93.5.2.3.

Examples:

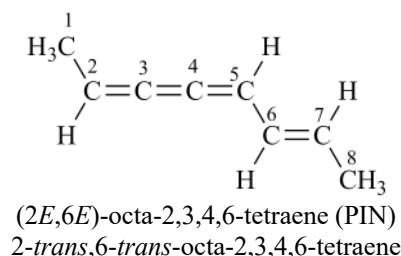
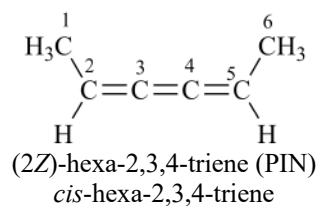

P-93.4.2.4 Specification of configuration in compounds with multiple stereogenic units

When chiral compounds contain multiple double bonds, >C=C<, stereodescriptors are assigned as described above. Stereodescriptors are cited at the front of the name or of any substituent group or appropriate portion of the name, in ascending order of the locants. For a discussion about the nomenclature of these unsaturated compounds, see P-92.4.2.

Examples:

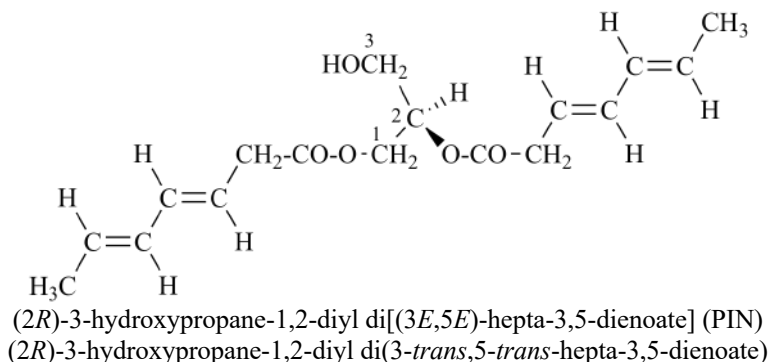
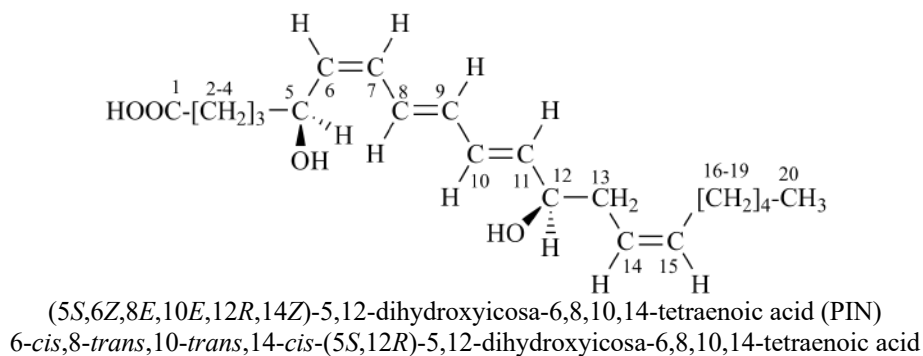

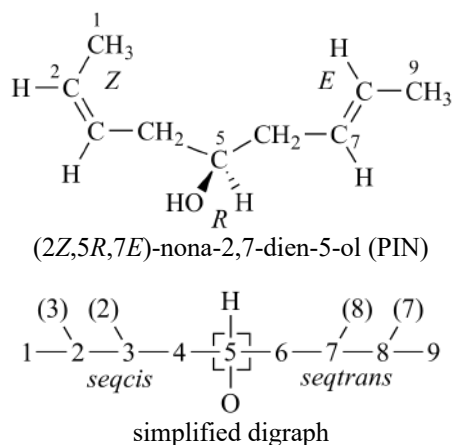

P-93.5 CONFIGURATION SPECIFICATION OF CYCLIC ORGANIC COMPOUNDS

- P-93.5.0 Introduction
- P-93.5.1 Monocyclic compounds
- P-93.5.2 von Baeyer compounds
- P-93.5.3 Spiro compounds
- P-93.5.4 Fused and bridged fused compounds
- P-93.5.5 Cyclophanes
- P-93.5.6 Fullerenes
- P-93.5.7 Ring assemblies

P-93.5.0 Introduction

The application of CIP stereodescriptors to monocyclic compounds is discussed in this section. Stereodescriptors used before the CIP system was established are still recommended for general nomenclature and are mandatory in the field of Natural Products as indicated in Chapter P-10.

The following non-CIP stereodescriptors are used in general IUPAC substitutive nomenclature: '*cis*', '*trans*' (see P-93.5.1.2); '*r*', '*c*', '*t*' (see P-93.5.1.3); '*endo*', '*exo*', '*syn*', '*anti*' (see P-93.5.2.2.1).

P-93.5.1 Monocyclic compounds

- P-93.5.1.1 Specification of stereogenic centers: stereodescriptors '*R*', '*S*', '*r*', and '*s*'
- P-93.5.1.2 Relative configuration: stereodescriptors '*cis*' and '*trans*'
- P-93.5.1.3 Relative configuration: stereodescriptors '*r*', '*c*', and '*t*'
- P-93.5.1.4 Unsaturated alicyclic compounds

P-93.5.1.1 Specification of stereogenic centers: stereodescriptors '*R*', '*S*', '*r*', and '*s*'

P-93.5.1.1.1 Absolute configuration

In substituted monocyclic compounds the absolute configuration is specified in preferred IUPAC names by the CIP stereodescriptors such as '*R*', '*S*', '*r*', and '*s*'.

Examples:

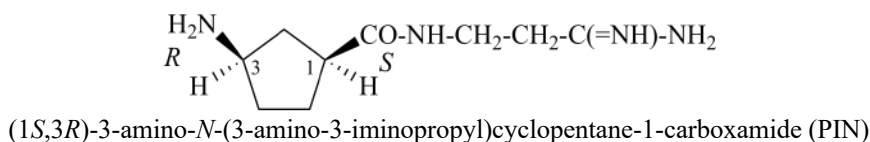
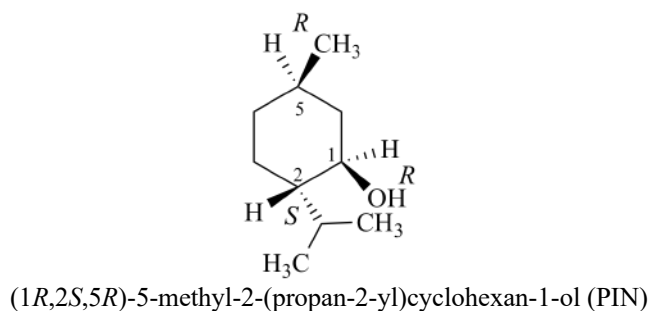

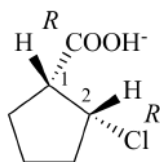

(1*R*,2*R*)-2-chlorocyclopentane-1-carboxylic acid (PIN)

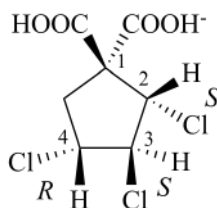

(2*S*,3*S*,4*R*)-2,3,4-trichlorocyclopentane-1,1-dicarboxylic acid (PIN)

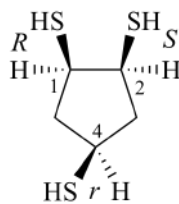

(1*R*,2*S*,4*r*)-cyclopentane-1,2,4-trithiol (PIN)

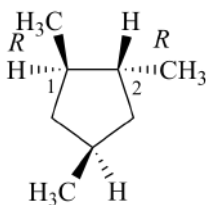

(1*R*,2*R*)-1,2,4-trimethylcyclopentane (PIN)

(no stereodescriptor is assigned to C-4; it is a nonstereogenic center)

P-93.5.1.1.2 Achiral cyclic compounds

The configuration of achiral cyclic molecules is also specified by CIP stereodescriptors in preferred IUPAC names.

(a) The configuration at pseudoasymmetric centers, for example, at 'C-1' and 'C-4' of 1,4-disubstituted cyclohexanes, is specified by the methodology discussed in Example 2 in P-92.6.

Examples:



(1*s*,4*s*)-cyclohexane-1,4-diol (PIN)
cis-cyclohexane-1,4-diol

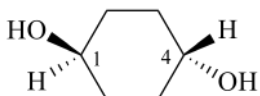

(1*r*,4*r*)-cyclohexane-1,4-diol (PIN)
trans-cyclohexane-1,4-diol



(1*r*,4*r*)-4-chloro-4-methylcyclohexan-1-ol (PIN)
trans-4-chloro-4-methylcyclohexan-1-ol

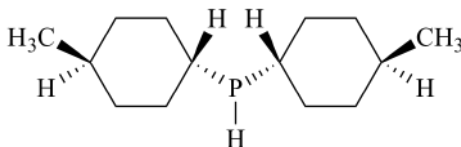

bis[(1*r*,4*r*)-4-methylcyclohexyl]phosphane (PIN)
bis(*trans*-4-methylcyclohexyl)phosphane

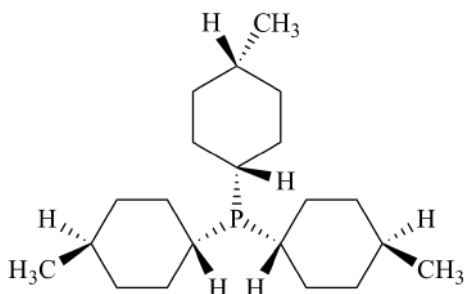

bis[(1*r*,4*r*)-4-methylcyclohexyl][(1*s*,4*s*)-4-methylcyclohexyl]phosphane (PIN)
 (*cis*-4-methylcyclohexyl)bis(*trans*-4-methylcyclohexyl)phosphane

(b) The achiral isomers of 1,2,3,4,5,6-hexasubstituted cyclohexane by identical substituents are described below. By the method described in P-92.5, for the chiral isomer, Sequence Rule 4 is applied exhaustively; then, Sequence Rule 5 (see P-92.6) is used to name pseudoasymmetric stereogenic centers. Stereodescriptor sets of CIP stereodescriptors are described for each diastereoisomer, numbered 1 through 7; they are to be inserted at the front of the substitutive name, as shown here for the first enantiomer in the series shown below: (1*R*,2*R*,3*S*,4*R*,5*S*,6*S*)-1,2,3,4,5,6-hexachlorocyclohexane (see P-93.5.1.3.2 for the preferred IUPAC name, 1,2,3,4,5,6-hexachlorocyclohexane). The numbering for these examples is decided by application of criterion P-14.4 (j).

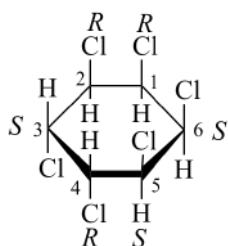

1 (1*R*,2*R*,3*S*,4*R*,5*S*,6*S*)

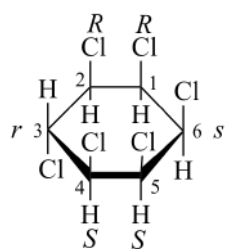

2 (1*R*,2*R*,3*r*,4*S*,5*S*,6*s*)

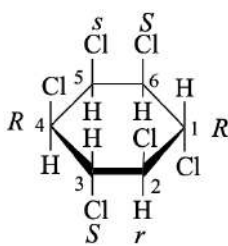

3 (1*R*,2*S*,3*r*,4*R*,5*S*,6*s*)

Note $R > r > S > s$ [see P-14.4 (j)]

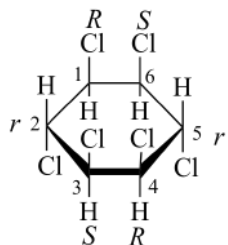

4 (1*R*,2*r*,3*S*,4*R*,5*r*,6*S*)

Note $R > r > S > s$ [see P-14.4 (j)]

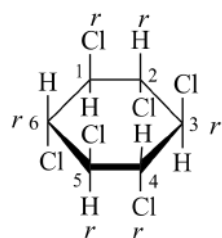

5 (1*r*,2*r*,3*r*,4*r*,5*r*,6*r*)

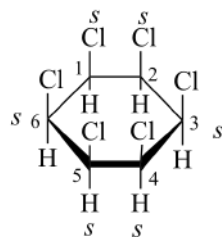

6 (1*s*,2*s*,3*s*,4*s*,5*s*,6*s*)

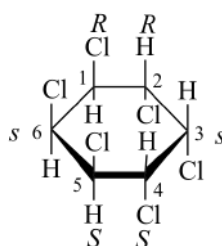

7 (1*R*,2*R*,3*s*,4*S*,5*S*,6*s*)

P-93.5.1.2 Relative configuration: the stereodescriptors 'cis' and 'trans'

The stereodescriptors 'cis' and 'trans' are used to show the relationship between two ligands (atoms or groups) attached to separate atoms that are contained in a ring or a ring system. The two ligands are said to be located 'cis' to each other if they lie on the same side of a plane. If they are on opposite sides, their relative position is described as 'trans'. The appropriate reference plane of a ring or ring system (the ring being in a conformation, real or assumed, without reentrant angles at the two substituted atoms) is the mean plane of the ring(s). The stereodescriptors denote relative configuration; the absolute configuration must be described by CIP stereodescriptors such as 'R' and 'S'.

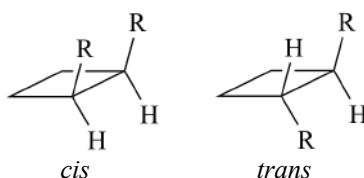

The structures below look like 'cis/trans-isomers', but are actually different conformations of the same 'cis' stereoisomer. In the conformation on the left hand side, the stereogenic center at 'C-1' is located on a reentrant angle.

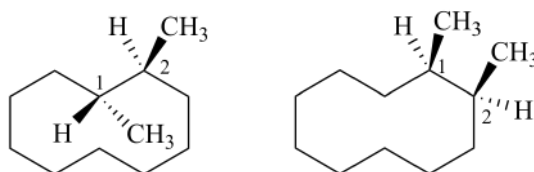

When one ligand and one hydrogen atom are attached at each of two positions of a monocycle, the steric relation (the relative configuration) of the two ligands is expressed as 'cis' or 'trans', followed by a hyphen and placed before the name of the compound. No locants are required before the stereodescriptors. In names, 'cis' arrangements of ligands are cited before 'trans' isomers, when a choice is possible. To describe the relative configuration the stereodescriptors 'R' and 'S' preceded by the term 'rel' are preferred to 'R*' and 'S*', and also to 'cis' and 'trans' (see P-93.1.2).

Examples:

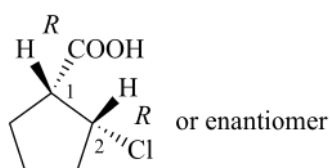

cis-2-chlorocyclopentane-1-carboxylic acid
rel-(1*R*,2*R*)-2-chlorocyclopentane-1-carboxylic acid (PIN)
 (1*R**,2*R**)-2-chlorocyclopentane-1-carboxylic acid
 [not *rel*-(1*S*,2*S*)-2-chlorocyclopentane-1-carboxylic acid]
 [not (1*S**,2*S**)-2-chlorocyclopentane-1-carboxylic acid]

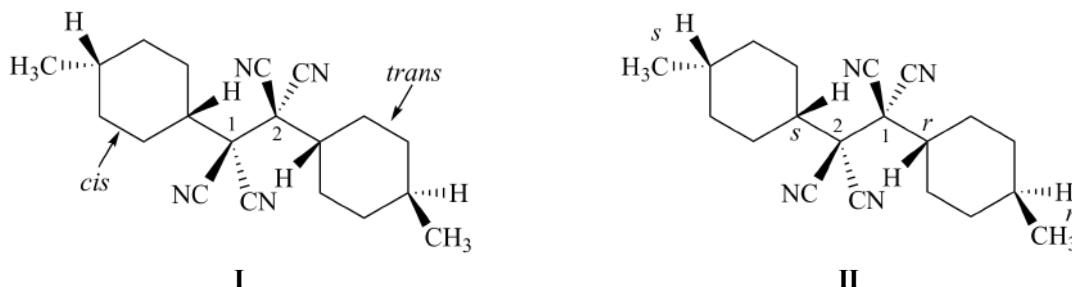

(I) 1-(*cis*-4-methylcyclohexyl)-2-(*trans*-4-methylcyclohexyl)ethane-1,1,2,2-tetracarbonitrile
 (II) 1-[(1*r*,4*r*)-4-methylcyclohexyl]-2-[(1*s*,4*s*)-4-methylcyclohexyl]ethane-1,1,2,2-tetracarbonitrile (PIN;
 the use of CIP stereodescriptors generates the preferred IUPAC name)

Explanation: In structure I, the locant '1' is assigned to the non-CIP stereodescriptor '*cis*'; and in structure II to the CIP stereodescriptor '*r*'. In names, the stereodescriptor '*cis*' is cited before '*trans*' and '*r*' before '*s*'.

P-93.5.1.3 Relative configuration; the stereodescriptors '*r*', '*c*', and '*t*'

P-93.5.1.3.1 When one substituent and one hydrogen atom are attached to each of more than two positions of a monocycle, the steric relations of the ligands are expressed by adding '*r*' (the reference ligand) after the locant of the lowest numbered of these ligands, and '*c*' for '*cis*' and '*t*' for '*trans*' (as required) after the locant of another ligand, thus expressing the relationship to the reference ligand. The relative configuration is expressed by these stereodescriptors. Furthermore, racemates may also be denoted by this method. For preferred IUPAC names, the preferred stereodescriptors are those used in the CIP priority system described in P-91 and P-92, with stereodescriptors such as '*R*' and '*S*' to describe absolute configuration and the prefixes '*rel*' to express relative configuration and '*rac*' for racemates, as described in P-93.1.3.

The notation consisting of adding '*r*' (for reference substituent) after the locant of the lowest numbered of these substituents and '*c*' (for *cis*) and '*t*' (for *trans*) (as appropriate) and the locant for another substituent, as used in the 1993 Guide to IUPAC Nomenclature of Organic Compounds (ref. 2), is no longer recommended.

Example 1:

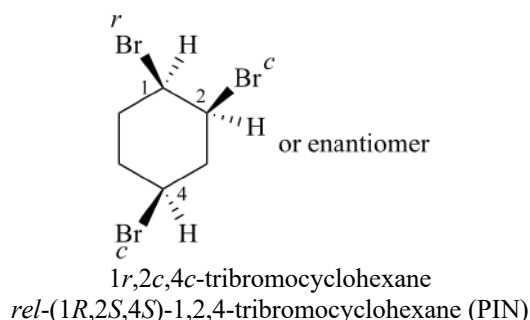

Example 2:

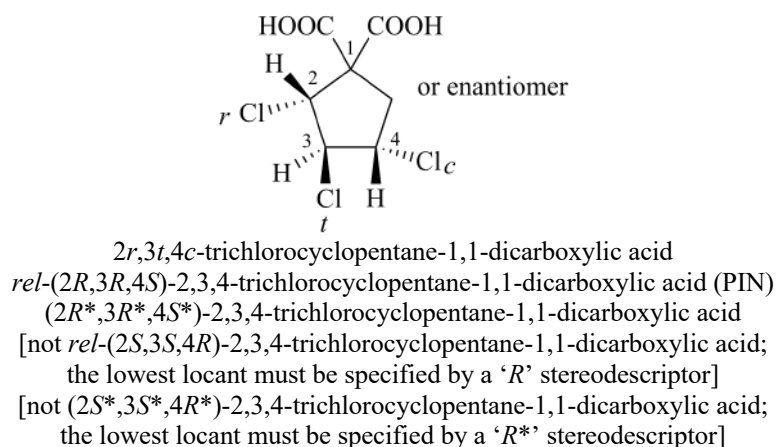

P-93.5.1.3.2 When two different ligands are attached at the same position of a monocycle, then the lowest-numbered ligand named as a suffix is chosen as reference ligand. If none of the ligands is named as a suffix, then one of the ligands having the lowest locant and higher ranking in the Sequence Rule is chosen as a reference ligand. The relationship of the Sequence-Rule-higher ranking at geminally substituted positions, relative to the reference group, is cited as '*c*' or '*t*', as required.

Example 1:

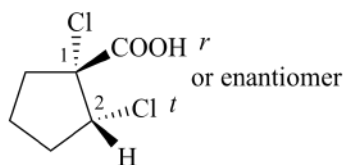

1,2-dichlorocyclopentane-1*r*-carboxylic acid
rel-(1*R*,2*R*)-1,2-dichlorocyclopentane-1-carboxylic acid (PIN)

Example 2:

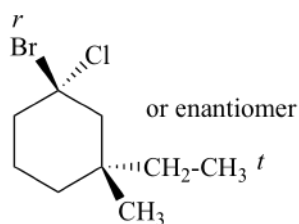

1*r*-bromo-1-chloro-3*t*-ethyl-3-methylcyclohexane
rel-(1*R*,3*R*)-1-bromo-1-chloro-3-ethyl-3-methylcyclohexane (PIN)
 (1*R**,3*R**)-1-bromo-1-chloro-3-ethyl-3-methylcyclohexane

Example 3:

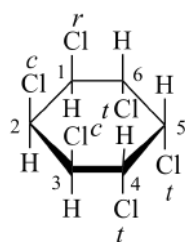

(1*R*,2*R*,3*S*,4*S*,5*S*,6*S*)-1,2,3,4,5,6-hexachlorocyclohexane (PIN)
 1*r*,2*c*,3*c*,4*t*,5*t*,6*t*-hexachlorocyclohexane

Explanation: In this compound, different numberings are necessary in accordance with the precedence of '*R*' ligands and '*cis*' arrangements for lowest locants [this compound is example 7 discussed in P-93.5.1.1.2 (b); other isomers are described in P-92.5.2.2 and P-93.5.1.1.2 (b).]

P-93.5.1.4 Unsaturated alicyclic compounds

P-93.5.1.4.1 Specification of cyclic double bonds

P-93.5.1.4.2 Specification of *exo*-cyclic double bonds

P-93.5.1.4.1 Specification of cyclic double bonds

In three- to seven-membered monocycles, cyclic double bonds have a '*cis*' configuration; the stereodescriptor, '*Z*' or '*cis*', denoting the configuration of the cyclic double bonds (double bonds that are included in the ring) is permanently omitted. From eight-membered monocycles members onward, cyclic double bonds can be either '*cis*' or '*trans*'; the stereodescriptors '*Z*' and '*E*', must be used in preferred IUPAC names, to specify such arrangements; the stereodescriptors '*cis*' and '*trans*' may be used in general nomenclature.

Examples:

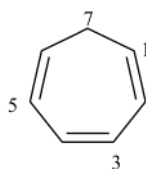

cyclohepta-1,3,5-triene (PIN)

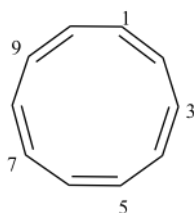

(1*Z*,3*Z*,5*Z*,7*Z*,9*Z*)-cyclodeca-1,3,5,7,9-pentaene (PIN)

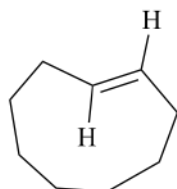

(*E*)-cyclononene (PIN)

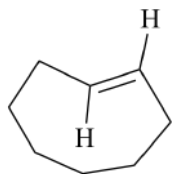

(*E*)-cyclooctene (PIN)

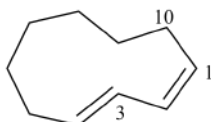

(1*Z*,3*E*)-cyclodeca-1,3-diene (PIN)

1-*cis*,3-*trans*-cyclodeca-1,3-diene

[lowest locants are assigned to the 'Z' double bond; see P-14.4 (j)]

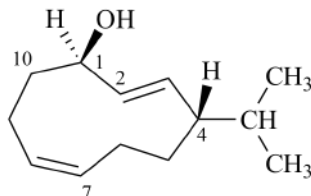

(1*R*,2*E*,4*S*,7*Z*)-4-(propan-2-yl)cyclodeca-2,7-dien-1-ol (PIN)

2-*trans*,7-*cis*-(1*R*,4*S*)-4-(propan-2-yl)cyclodeca-2,7-dien-1-ol

The stereodescriptors '*M*', '*P*', '*R_p*', or '*S_p*' are used to denote the configuration of '*E*' chiral isomers of cycloalkenes. The stereodescriptors '*M*' and '*P*' are used in preferred IUPAC names.

Example:

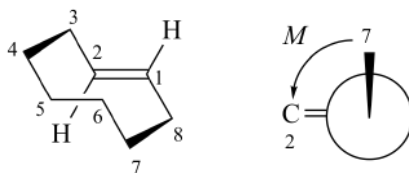

(1*E*,1*M*)-cyclooct-1-ene (PIN)

(*E*,*M*)-cyclooctene

(*E*,*S_p*)-cyclooctene

P-93.5.1.4.2 Specification of *exo*-cyclic double bonds

P-93.5.1.4.2.1 Specification by stereodescriptors '*E*' and '*Z*'

The stereodescriptors '*E*' and '*Z*' are used to specify the configuration of an *exo*-cyclic double bond.

(1) When one double bond is present, two methods are used to construct the names

(a) the double bond is considered as an integral part of the parent structure; the stereodescriptor is placed at the front of the substitutive name, preceded by the locant indicating its point of attachment to the parent structure;

(b) the double bond is considered as part of the substituent group of the 'ylidene' type. The stereodescriptor is cited at the front of the name of the substituent group; the name of the corresponding prefix is then placed in enclosing marks.

Method (a) generates preferred IUPAC names.

Examples:

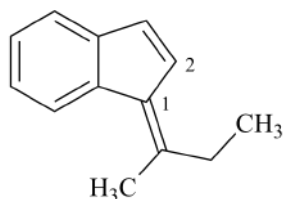

(1*E*)-1-(butan-2-ylidene)-1*H*-indene (PIN)
[(2*E*)-butan-2-ylidene]-1*H*-indene

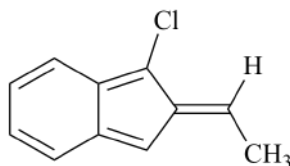

(2*E*)-1-chloro-2-ethylidene-2*H*-indene (PIN)
1-chloro-2-[(*E*)-ethylidene]-2*H*-indene

(2) When two double bonds are attached to the same ring, the two methods described in (1) are applied. Each double bond is specified by method (a) in preferred IUPAC names. A third method is also used in general nomenclature, in which the ring is considered as a formal double bond and the entire system specified as a cumulene with an odd number of double bonds (see P-93.4.2.3). This method is only valid with a $2n$ -membered monocyclic ring substituted in opposite positions. Otherwise method (a) is used.

Example 1:

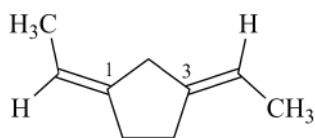

(1*Z*,3*E*)-1,3-diethylidenecyclopentane (PIN)
1-[(*Z*)-ethylidene]-3-[(*E*)-ethylidene]cyclopentane

Example 2:

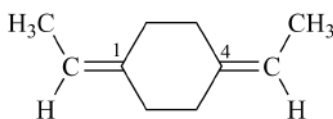

(1*Z*,4*Z*)-1,4-diethylidenecyclohexane (PIN)
(see Example 1 in P-92.4.2.2 for specifying a 'Z' configuration at 'C-1' and 'C-4')
cis-1,4-diethylidenecyclohexane
1,4-di[(*Z*)-ethylidene]cyclohexane

Example 3:

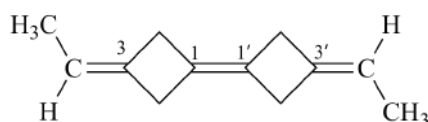

[1(1'*E*),3*E*,3'*E*]-3,3'-diethylidene-1,1'-bi(cyclobutylidene) (PIN)
trans-3,3'-diethylidene-1,1'-bi(cyclobutylidene)
3,3'-di[(*E*)-ethylidene]-1,1'-bi(cyclobutylidene)

Explanation:

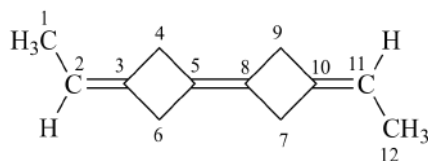

arbitrarily renumbered structure in order to establish the required digraphs:

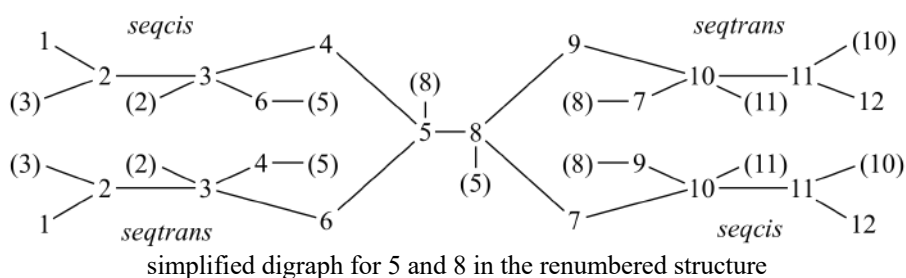

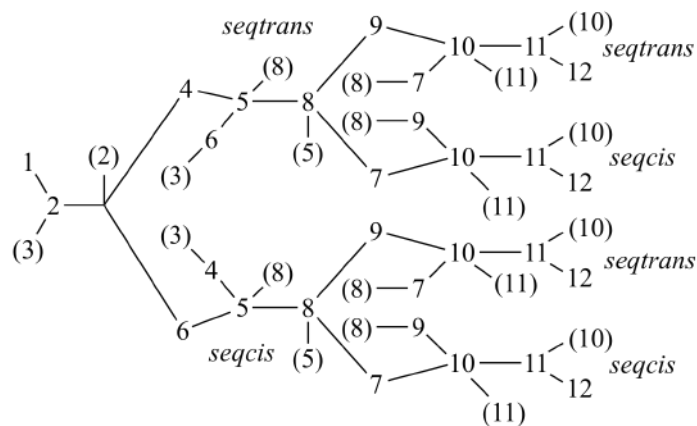

simplified digraph for 2 and 3 in the renumbered structure

P-93.5.1.4.2.2 Specification of *exo*-cyclic double bonds by stereodescriptors other than '*E*' and '*Z*'.

Compounds composed of a substituted ring and an *exo*-cyclic double bond can be considered as an allene system and named in two ways:

- (1) by identifying and specifying individual stereogenic units
- (2) by considering the entire molecule as a unique system and naming as such

IUPAC names are based on method (1).

Example 1:

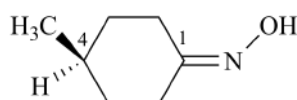

(1*seqCis*,4*R*)-*N*-hydroxy-4-methylcyclohexan-1-imine (PIN)
 [(1*seqCis*,4*R*)-4-methylcyclohexylidene]hydroxylamine
 [for '*seqCis*' see P-92.1.1 (f)]
 (*M*)-(4-methylcyclohexylidene)hydroxylamine
 (*R_a*)-4-methylcyclohexanone oxime

Explanation: The following digraphs are used for specifying the configurations 'C-1' and 'C-4':

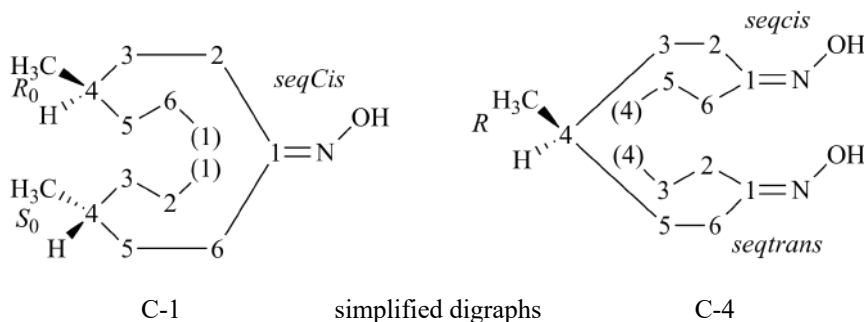

C-1

simplified digraphs

C-4

Example 2:

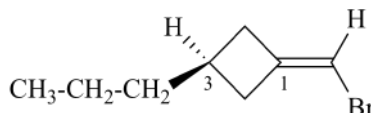

(1*seqCis*,3*S*)-1-(bromomethylidene)-3-propylcyclobutane (PIN)
 (*P*)-1-(bromomethylidene)-3-propylcyclobutane
 (*S_a*)-1-(bromomethylidene)-3-propylcyclobutane

Example 3:

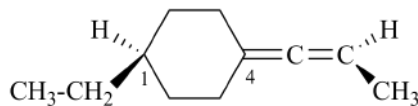

(1*s*,4*p*)-1-ethyl-4-(prop-1-en-1-ylidene)cyclohexane (PIN)
 (1*s*,4*s_a*)-1-ethyl-4-(prop-1-en-1-ylidene)cyclohexane

Explanation: The following digraphs are used for specifying the configurations 'C-1' and 'C-4':

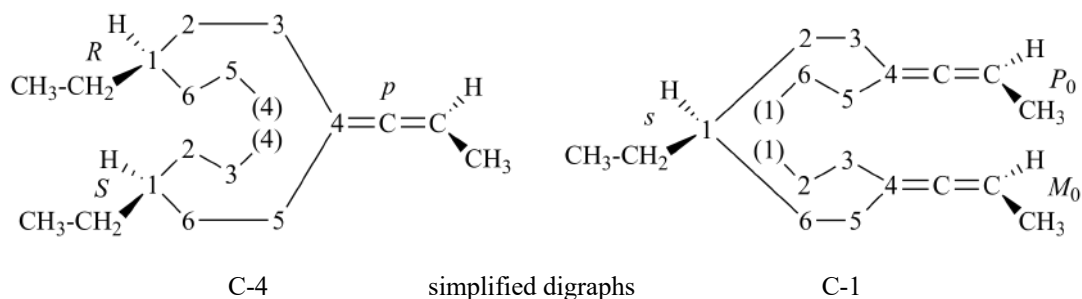

Example 4:

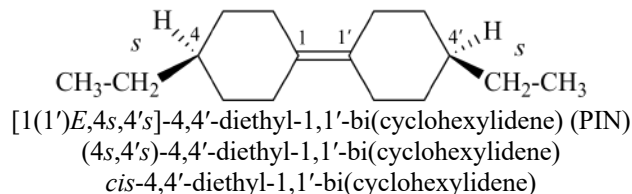

Explanation: The following digraphs are used in the specification of the configuration at the stereogenic double bond and the stereogenic center 'C-4' (shown):

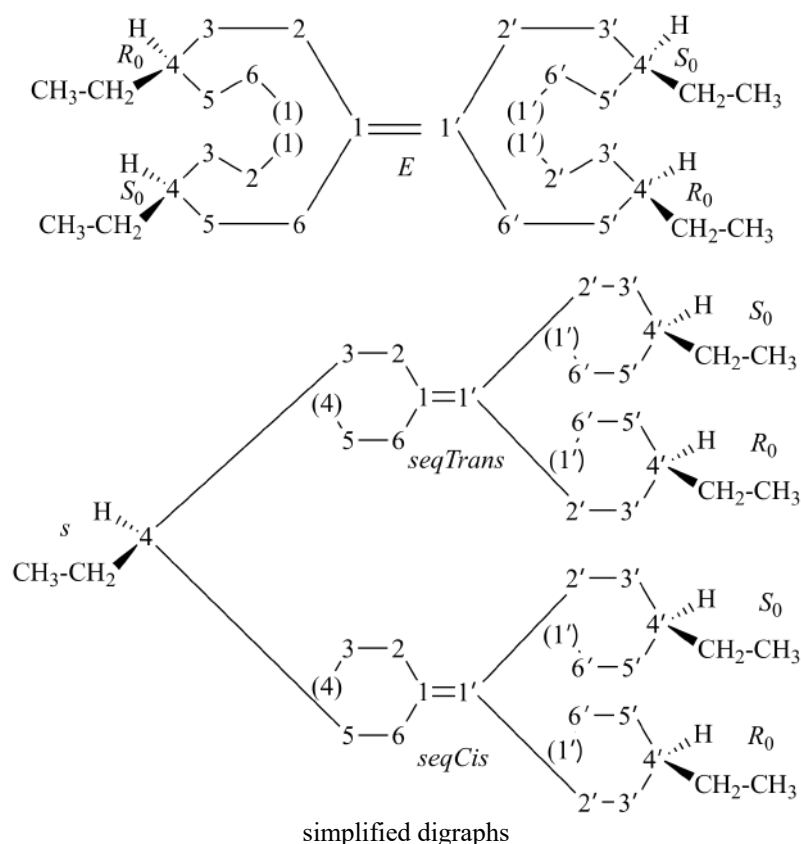

Explanation: The configuration of the double bond 'C-1=C-1'' is determined as follows. The auxiliary stereodescriptors on each side of the double bond are '*R*₀' and '*S*₀'; priority being given to '*R*₀' over '*S*₀', the ligands '2' and '6' permit an '*E*' configuration to be assigned. The configuration at 'C-4' is determined as follows. In the digraph, the configurations '*R*₀' and '*S*₀' permit, in each branch the determination of the configuration of the auxiliary stereodescriptor '*seqCis*' and '*seqTrans*' for the double bonds 'C-1=C-1''; priority being assigned to '*seqCis*' according to Sequence Rule 5, the ligand 'C-5' has priority over ligand 'C-3', thus permitting the configuration '*s*' to be assigned according to Sequence Rule 5.

Note: While there is a *cis* arrangement of substituents, CIP descriptors include *E*, which cannot be used alone, to describe the configuration of the structure.

P-93.5.2 von Baeyer compounds

P-93.5.2.1 Specification of stereogenic centers by CIP stereodescriptors

P-93.5.2.2 Relative configuration

P-93.5.2.3 Specification of double bonds

P-93.5.2.1 Specification of stereogenic centers by CIP stereodescriptors

The absolute configuration with a unique numbering determined by the structure is specified by CIP stereodescriptor such as '*R*', '*S*', etc.

Examples:

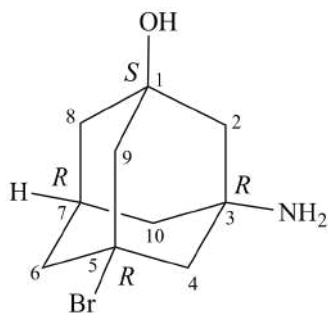

(1*S*,3*R*,5*R*,7*R*)-3-amino-5-bromoadamantan-1-ol (PIN)
 (1*S*,3*R*,5*R*,7*R*)-3-amino-5-bromotricyclo[3.3.1.1^{3,7}]decan-1-ol

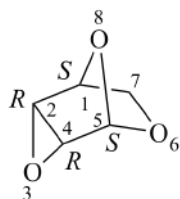
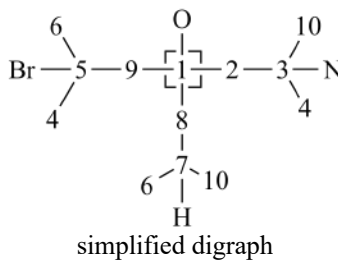

(1*S*,2*R*,4*R*,5*S*)-3,6,8-trioxatricyclo[3.2.1.0^{2,4}]octane (PIN)

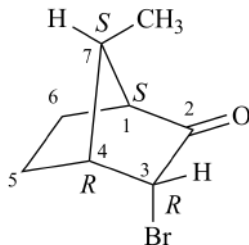

(1*S*,3*R*,4*R*,7*S*)-3-bromo-7-methylbicyclo[2.2.1]heptan-2-one (PIN)

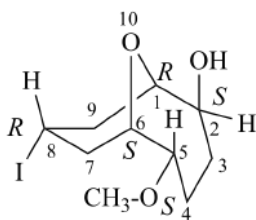

(1*R*,2*S*,5*S*,6*S*,8*R*)-8-iodo-5-methoxy-10-oxabicyclo[4.3.1]decan-2-ol (PIN)

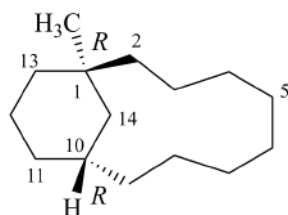

(1*R*,10*R*)-1-methylbicyclo[8.3.1]tetradecane (PIN)

P-93.5.2.2 Relative configuration

Relative configuration and racemates are specified by using the stereodescriptors '*R*' and '*S*' and prefixes '*rel*' and '*rac*' as described in P-93.1.2 and P-93.1.3.

P-93.5.2.2.1 The stereodescriptors '*endo*', '*exo*', '*syn*', and '*anti*'

These stereodescriptors are used to indicate the relative orientation of groups attached to nonbridgehead atoms in bicyclo[x.y.z]alkanes, where 'x ≥ y > z > 0', and with the additional provision that the two bridges 'x + y' must be smaller than '7'. In fact, these stereodescriptors are used to describe the relative configuration of bi- and tricyclic systems such as bicyclo[2.2.1]heptanes, bicyclo[3.2.1]octane, and bicyclo[3.3.1]nonane.

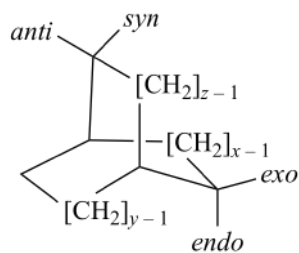

If the substituent is orientated toward the highest numbered bridge ('Z' bridge, e.g. 'C-7' in example below) it is given the description 'exo'; if it is orientated away from the highest numbered bridge it is given the description 'endo'. If the substituent is attached to the highest numbered bridge and is orientated toward the lowest numbered bridge ('x' bridge, e.g. 'C-2' in example below) it is given the description 'syn'; if the substituent is orientated away from the lowest numbered bridge it is given the description 'anti'. In names, the stereodescriptors are cited between the locant and the substituent, with connecting hyphens.

The stereodescriptors 'endo', 'exo', 'syn', and 'anti' describe relative configuration only; they do not permit to distinguish between a single enantiomer (first example below) and a racemate (second example below); the phrase 'and/or enantiomer' is used to denote these two possibilities. The absolute configuration must be described by CIP stereodescriptors such as 'R' and 'S'; these stereodescriptors, accompanied by the prefixes 'rel' and 'rac', permit a full description of any given compound.

Examples:

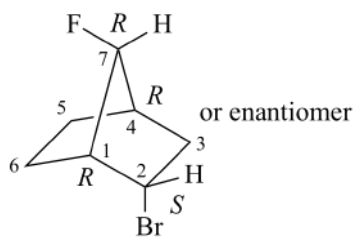

2-endo-bromo-7-anti-fluorobicyclo[2.2.1]heptane
rel-(1R,2S,4R,7R)-2-bromo-7-fluorobicyclo[2.2.1]heptane (PIN)

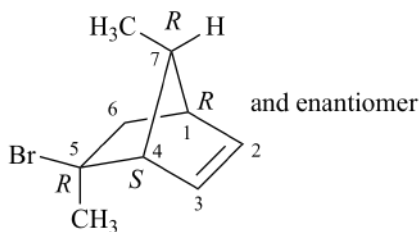

(±)-5-exo-bromo-5-endo,7-anti-dimethylbicyclo[2.2.1]hept-2-ene
rac-(1R,4S,5S,7R)-5-bromo-5,7-dimethylbicyclo[2.2.1]hept-2-ene (PIN)

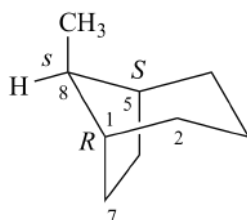

8-syn-methylbicyclo[3.2.1]octane
(1R,5S,8s)-8-methylbicyclo[3.2.1]octane (PIN)

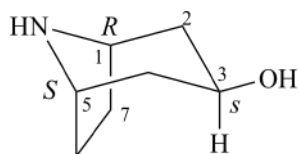

(1R,3s,5S)-8-azabicyclo[3.2.1]octan-3-ol
(3s)-8-nortropan-3-ol
8-azabicyclo[3.2.1]octan-3-exo-ol

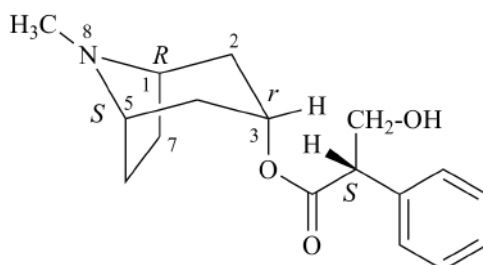

(1*R*,3*r*,5*S*)-8-methyl-8-azabicyclo[3.2.1]octan-3-yl (2*S*)-3-hydroxy-2-phenylpropanoate
 8-methyl-8-azabicyclo[3.2.1]octan-3-*endo*-yl (2*S*)-3-hydroxy-2-phenylpropanoate
 tropan-3 α -yl (2*S*)-3-hydroxy-2-phenylpropanoate (see P-101.7.3)

P-93.5.2.2.2 Stereodescriptors 'cis' and 'trans'

Stereodescriptors 'cis' and 'trans' can be used in general nomenclature only to specify the 'cis' or 'trans' arrangement of ligands on bridgeheads. CIP stereodescriptors, preceded by the prefix 'rel', must be used in association with preferred IUPAC names.

Example:

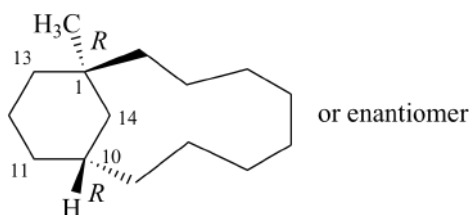

rel-(1*R*,10*R*)-1-methylbicyclo[8.3.1]tetradecane (PIN)
 (1*R**,10*R**)-1-methylbicyclo[8.3.1]tetradecane
 1-methyl-*trans*-bicyclo[8.3.1]tetradecane

P-93.5.2.3 Specification of double bonds

As described for cycloalkenes (see P-93.5.1.4.1), in unsaturated bicyclo[3.3.3]undecane and smaller systems, it is not necessary to identify the configuration of double bonds as 'Z'. All double bonds in larger systems need to be specified as 'Z' or 'E'.

Examples:



bicyclo[2.2.1]hept-2-ene (PIN)



bicyclo[2.2.2]octa-2,5,7-triene (PIN)

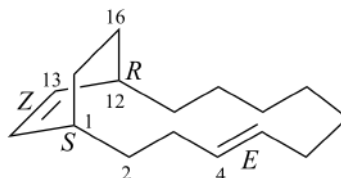

(1*S*,4*E*,12*R*,13*Z*)-bicyclo[10.2.2]hexadeca-4,13-diene (PIN)
 (1*S*,4*E*,12*R*)-bicyclo[10.2.2]hexadeca-4,13-diene

Cumulene systems included in cyclic systems are treated as discussed in P-93.4.2.2 and P-93.4.2.3 and numbered according to the numbering of the cyclic system. In names the first locant of an 'E/Z' system or of an axial stereogenic unit ('M/P' system) is cited. Compound locants (see P-14.3 and P-31.1.4.2) are used when the locants of an individual double bond differ from more than one unit.

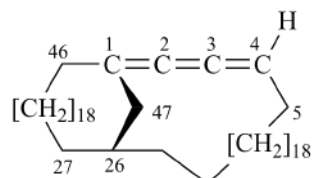

(1*Z*,26*R*)-bicyclo[24.20.1]heptatetraconta-1,2,3-triene (PIN)

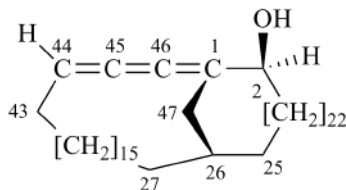

[1(44)*E*,2*S*,26*R*]-bicyclo[24.20.1]heptatetraconta-1(46),44,45-trien-2-ol (PIN)

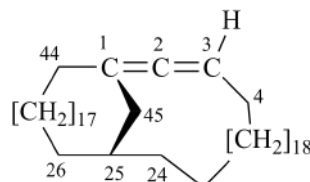

(1*P*,25*R*)-bicyclo[23.19.1]pentatetraconta-1,2-diene (PIN)

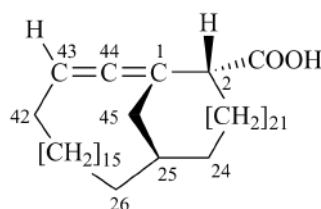

[1(43)*P*,2*R*,25*R*]-bicyclo[23.19.1]pentatetraconta-1(44),43-diene-2-carboxylic acid (PIN)

P-93.5.3 Spiro compounds

P-93.5.3.1 Specification of stereogenic spiro atoms of the type 'Xabcd', where 'a' > 'b' > 'c' > 'd'

P-93.5.3.2 Specification of stereogenic spiro atoms of the type 'Xabab', where 'a' > 'b'

P-93.5.3.3 Specification of double bonds

P-93.5.3.4 Specification of nontetrahedral stereogenic centers

P-93.5.3.5 Axial chirality of spiro compounds

P-93.5.3.1 Specification of stereogenic spiro atoms of the type 'Xabcd', where 'a' > 'b' > 'c' > 'd'

The stereodescriptors '*R*' and '*S*' are used when the spiro atom 'X' is surrounded by four atoms arranged as 'a > b > c > d'. These stereodescriptors are preferred to '*cis*' and '*trans*' that can be used to describe the relative configuration of rings in dispiro compounds. The configuration of any chirality centers located on the spiro skeleton is described by stereodescriptors '*R*' and '*S*' by using the usual method.

Example 1:

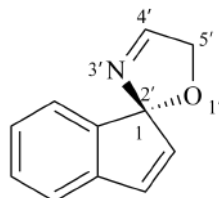

(1*R*)-5'*H*-spiro[indene-1,2'-[1,3]oxazole] (PIN)

Example 2:

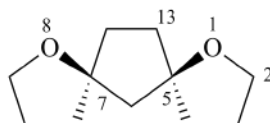

(5*R*,7*S*)-1,8-dioxadispiro[4.1.4⁷.2⁵]tridecane (PIN)
cis-1,8-dioxadispiro[4.1.4⁷.2⁵]tridecane

(the stereodescriptors '*cis*' and '*trans*' are used here by analogy with disubstituted monocycles described in P-93.5.1.2)

Example 3:

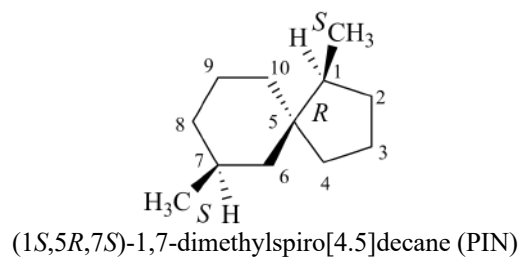

Example 4:

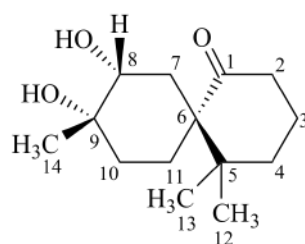
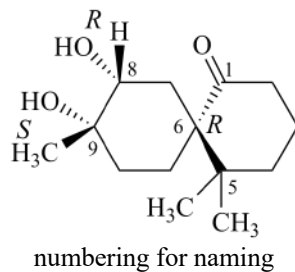

(6*R*,8*R*,9*S*)-8,9-dihydroxy-5,5,9-trimethylspiro[5.5]undecan-1-one (PIN)

Explanation:

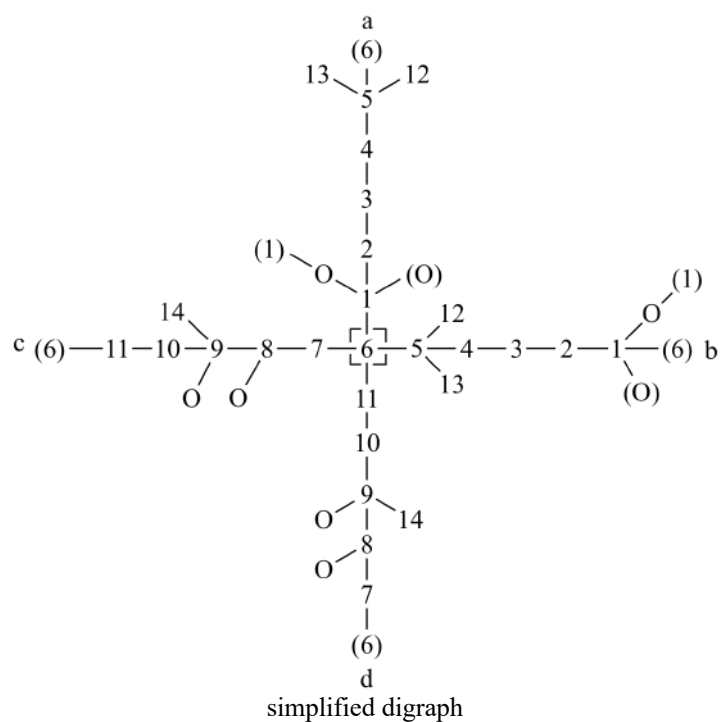

Example 5:

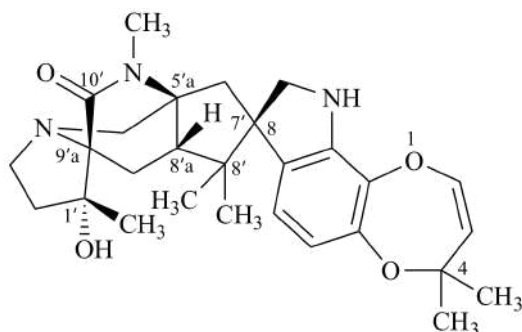

(1'*R*,5'*S*,7'*R*,8'*S*,9'*aR*)-1'-hydroxy-1',4,4,8',11'-hexamethyl-2',3',8'a,9,9',10-hexahydro-1'*H*,4*H*,5'*H*,6'*H*,8'*H*-spiro[[1,4]dioxepino[2,3-*g*]indole-8,7'-[5a,9a](azanomethano)cyclopenta[*f*]indolizin]-10'-one (PIN)

P-93.5.3.2 Specification of spiro atoms of the type 'Xabab', where 'a' > 'b'

The general methodology used to specify the central configuration of such systems is illustrated below.

Example 1:

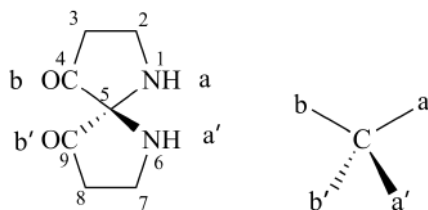

(5*R*)-1,6-diazaspiro[4.4]nonane-4,9-dione (PIN)

Explanation: In this example (see 2.5, ref. 34), the analysis to determine the order of ligands amongst equivalent pairs 'a'/'a'' and 'b'/'b'', where 'a' > 'b', starts at the nitrogen atom numbered 1, then goes to the nitrogen atom numbered 6; they are ranked 'a' and 'a'', respectively. The next ligand must be chosen between 'b' and 'b''; as shown in the digraph below, that branch is chosen that contains the nitrogen atom first chosen, i.e. 'a' that has precedence over 'a''; this choice leads the carbon atoms to be ranked as 'b' > 'b''. The configuration '*R*' at the spiro atom 'C-5' is determined by using the sequence $a > a' > b > b'$.

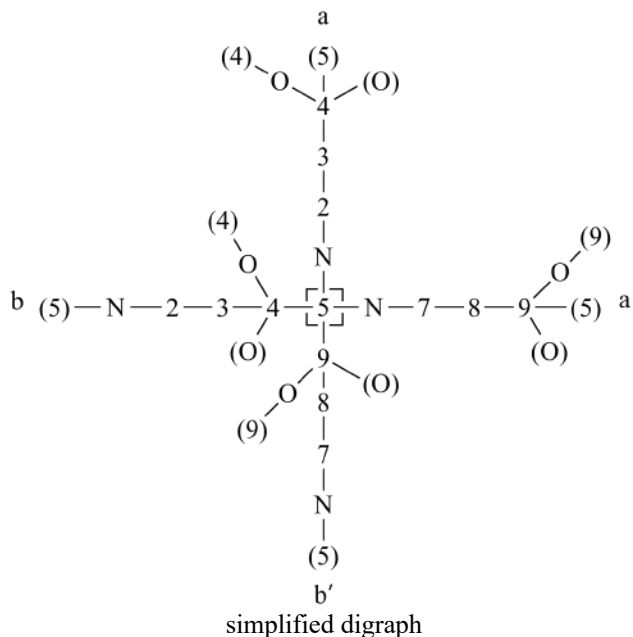

Example 2:

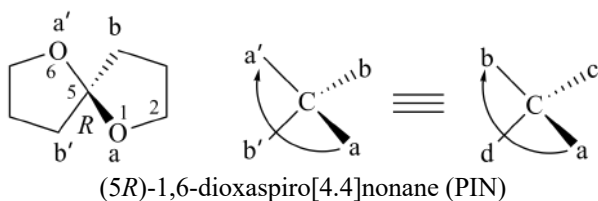

Example 3:

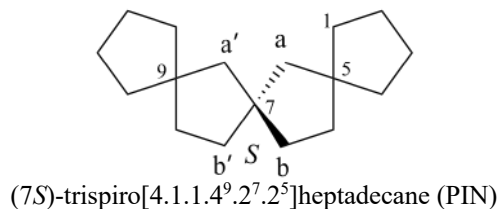

Example 4:

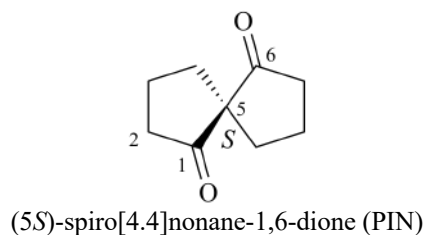

Example 5:

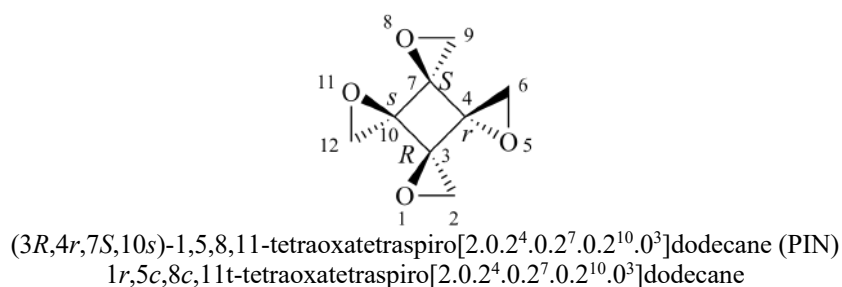

Note: In this example, stereogenic and pseudoasymmetric centers are present. Application of Sequence Rules 4 and 5 are necessary.

Explanation:

- configurations at 'C-3' and 'C-7' are determined by using Sequence Rule 4, *like* precedes *unlike*, in accordance with the methodology described in P-92.5;
- configurations at 'C-4' and 'C-10' are determined by using Sequence Rule 5, '*R*₀' precedes '*S*₀', in accordance with the methodology described in P-92.6.
- the numbering is chosen that gives a '*cis*' attachment at the first point of difference; see P-14.4 (j); thus '*1r,5c,8c,11t*', not '*1r,5t,8c,11c*';

P-93.5.3.3 Specification of double bonds

No stereodescriptor '*E*' or '*Z*' is needed to describe a double bond when the stereogenic unit is located in a ring having less than eight members. All stereodescriptors are used when a larger ring is present.

Examples:

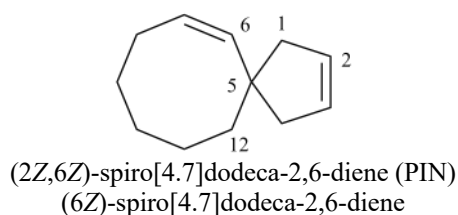
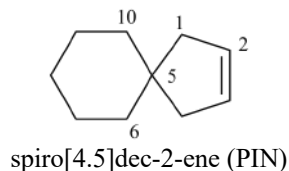

P-93.5.3.4 Specification of nontetrahedral stereogenic centers

As described in P-93.3.4.2, stereodescriptors '*A*' and '*C*', used in coordination chemistry, describe the relative and the absolute configuration of spiro compounds with λ⁴, λ⁵, and λ⁶-hetero spiro atoms.

Examples:

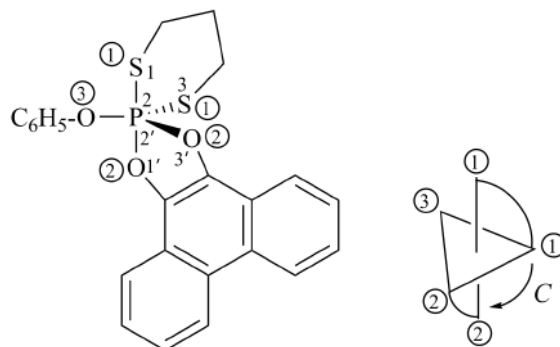

(*TBPY-5-12-C*)-2-phenoxy-2*H*-2λ⁵-spiro[[1,3,2]dithiaphosphinane-2,2'-phenanthro[9,10-*d*][1,3,2]dioxaphosphole] (PIN)

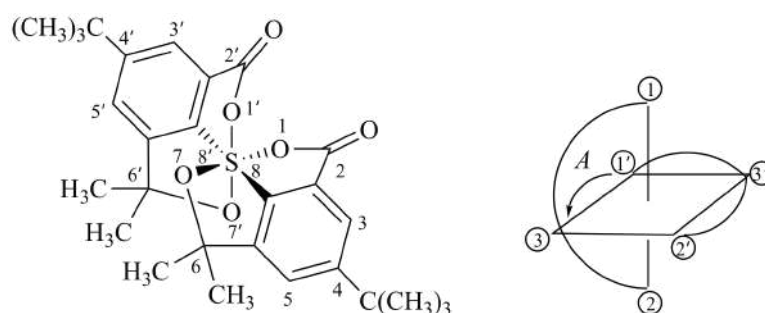

(*OC-6-22'-A*)-4,4'-di-*tert*-butyl-6,6,6',6'-tetramethyl-2*H*,2'*H*,6*H*,6'*H*-8λ⁶,8'-spirobi[[1,2]oxathio[4,3,2-*hi*][2,1]benzoxathiole]-2,2'-dione (PIN); (see P-93.3.3.7)

P-93.5.3.5 Axial chirality of spiro compounds

The stereodescriptors '*M*' and '*P*' are used to describe axial chirality of spiro compounds. The stereodescriptors '*R*' and '*S*' can also be used to describe the chirality centers that are present. Stereodescriptors '*R*' and '*S*' are used in preferred IUPAC names.

Example 1:

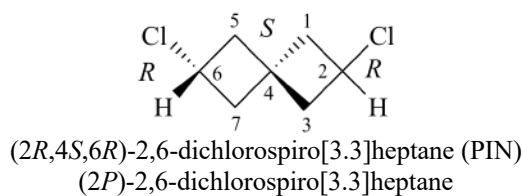

Explanation:

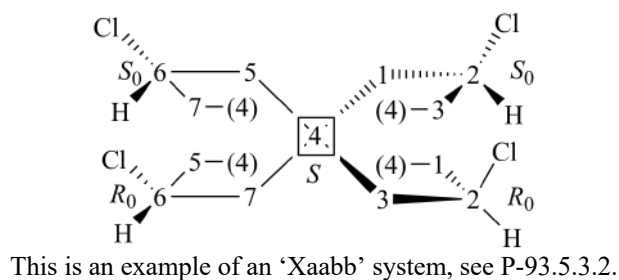

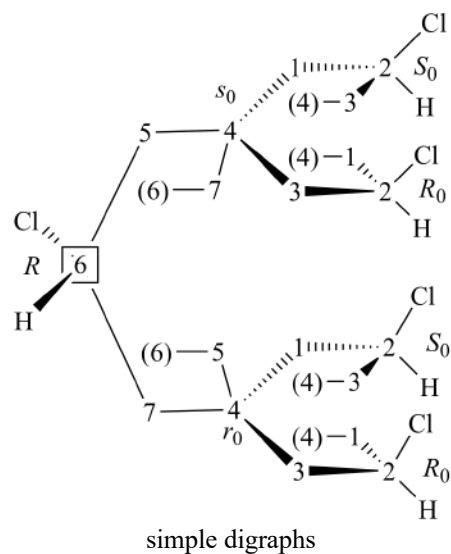
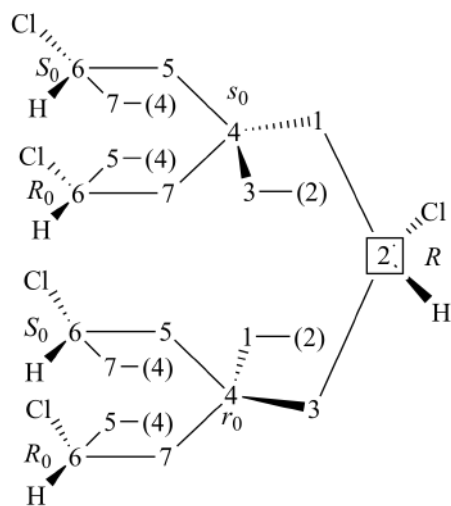

Example 2:

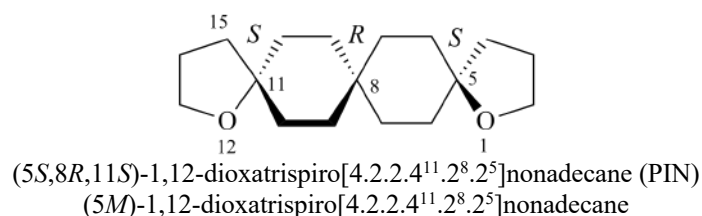

P-93.5.4 Fused and bridged fused compounds

P-93.5.4.1 Specification of configuration by CIP stereodescriptors

P-93.5.4.2 The descriptors '*cisoid*' and '*transoid*'

P-93.5.4.1 Specification of configuration by CIP stereodescriptors

A great variety of fused and bridged fused carbocyclic and heterocyclic compounds are described by specifying their stereogenic units as '*R*', '*S*', '*r*', '*s*', '*M*', and '*P*'. A few examples illustrate chirality associated with carbon and heteroatoms.

Examples:

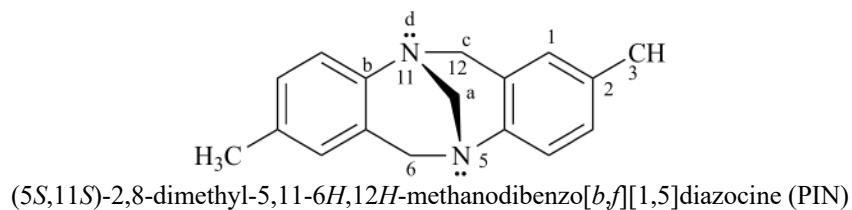

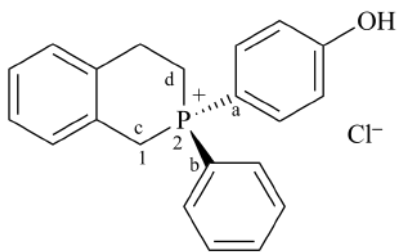

(2*S*)-2-(4-hydroxyphenyl)-2-phenyl-1,2,3,4-tetrahydroisophosphinolin-2-ium chloride (PIN)

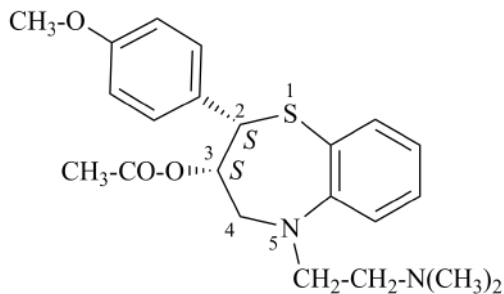

(2*S*,3*S*)-5-[2-(dimethylamino)ethyl]-2-(4-methoxyphenyl)-4-oxo-2,3,4,5-tetrahydro-1,5-benzothiazepin-3-yl acetate (PIN)

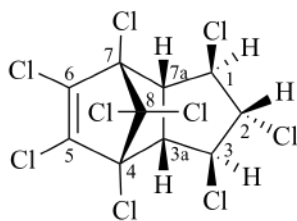

(1*R*,2*r*,3*S*,3*aR*,4*S*,7*R*,7*aS*)-1,2,3,4,5,6,7,8,8-nonachloro-2,3,3*a*,4,7,7*a*-hexahydro-1*H*-4,7-methanoindene (PIN)

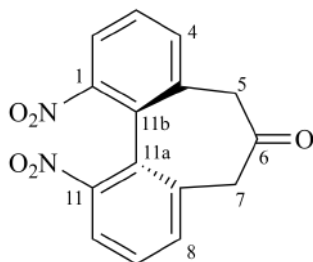

(11*aM*)-1,11-dinitro-5,7-dihydro-6*H*-dibenzo[*a,c*][7]annulen-6-one (PIN)
(11*aR_a*)-1,11-dinitro-5,7-dihydro-6*H*-dibenzo[*a,c*][7]annulen-6-one

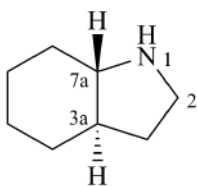

(3*aR*,7*aS*)-octahydro-1*H*-indole (PIN)
trans-octahydroindole

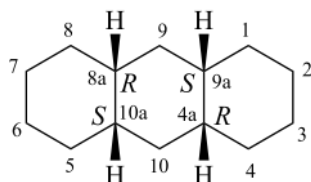

(4*aR*,8*aR*,9*aS*,10*aS*)-tetradecahydroanthracene (PIN)

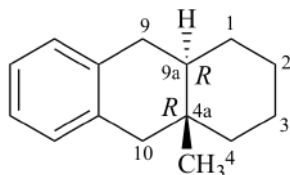

(4*aR*,9*aR*)-4*a*-methyl-1,2,3,4,4*a*,9,9*a*,10-octahydroanthracene (PIN)

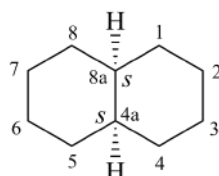

(4*as*,8*as*)-decahydronaphthalene (PIN)
cis-decahydronaphthalene

Explanation:

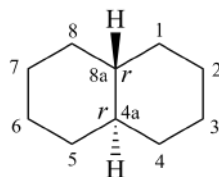
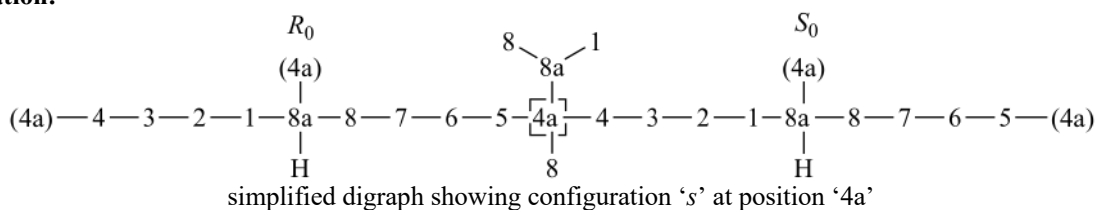

(4*ar*,8*ar*)-decahydronaphthalene (PIN)
trans-decahydronaphthalene

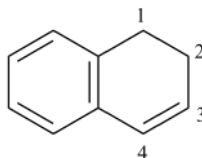

1,2-dihydronaphthalene (PIN)
(the double bond at 'C-3' is not specified as 'Z'; see P-93.5.1.4.1)

P-93.5.4.2 The descriptors '*cisoid*' and '*transoid*'

Steric relations at more than one pair of saturated fusion atoms in a fused system are denoted by '*cis*' and '*trans*', each followed by a hyphen, and, if necessary, the corresponding locant of the lower-numbered fusion atom and a second hyphen, all placed before the name of the ring system. Steric relations between the nearest atoms of *cis* or *trans* fusion pairs have been described by descriptors '*cisoid*' or '*transoid*' followed by a hyphen and, when required, the corresponding locants and a second hyphen, the whole placed between the designations of the '*cis*' or '*trans*' junctions concerned. The term 'nearest atom' denotes those atoms linked together through the smallest number of atoms, irrespective of the numbering of the system. When a choice remains between nearest atoms, the pair containing the lower numbered atom is selected.

The descriptors '*cisoid*' and '*transoid*' are not abbreviated. These descriptors are no longer recommended. The notation '*R*' and '*S*', with the descriptor '*rel*' is used instead for describing an enantiomer whose relative configuration only is known.

Examples:

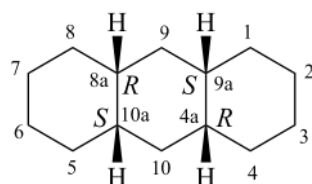

(4*aR*,8*aR*,9*aS*,10*aS*)-tetradecahydroanthracene (PIN)
cis-cisoid-cis-tetradecahydroanthracene
(this compound is achiral)

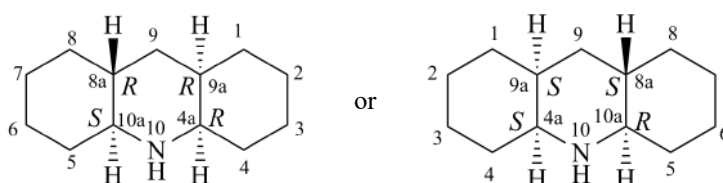

rel-(4*aR*,8*aR*,9*aR*,10*aS*)-tetradecahydroacridine (PIN)
cis-4*a*-*cisoid*-4*a*,10*a*-*trans*-10*a*-tetradecahydroacridine

P-93.5.5 Cyclophanes

- P-93.5.5.1 Specification of stereogenic planes
- P-93.5.5.2 Specification of chirality centers
- P-93.5.5.3 Specification of double bonds

P-93.5.5.1 Specification of stereogenic planes

The descriptors '*P*' and '*M*' are preferred to '*R_p*' and '*S_p*', respectively, to denote the stereogenic plane in accordance with the methodology described in P-92.1.2.1.3 and P-92.1.2.2.2. When there is a choice of ligands to determine the sense of chirality, the highest ranking in the CIP priority system is selected as reference. In cyclophanes, the composite locant of the ring or ring system that is viewed from the pilot atom is selected as locant to denote the stereogenic unit; this locant is placed at the front of the stereodescriptor.

Examples:

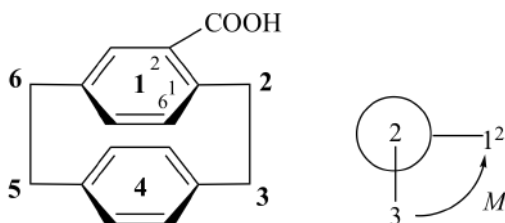

(¹*M*)-1,4(1,4)-dibenzencyclohexaphane-1²-carboxylic acid (PIN)
 (¹*S_p*)-1,4(1,4)-dibenzencyclohexaphane-1²-carboxylic acid

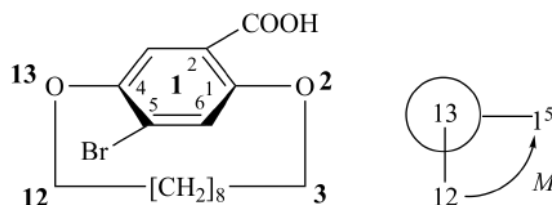

(¹*M*)-1⁵-bromo-2,13-dioxo-1(1,4)-benzenacyclotridecaphane-1²-carboxylic acid
 (¹*S_p*)-1⁵-bromo-2,13-dioxo-1(1,4)-benzenacyclotridecaphane-1²-carboxylic acid
 (*M*)-17-bromo-2,13-dioxabicyclo[12.2.2]octadeca-1(16),14,17-triene-15-carboxylic acid (PIN)

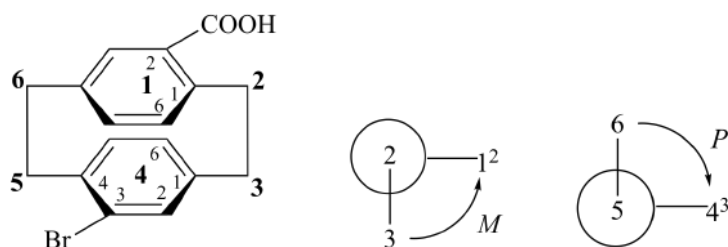

(¹*M*,⁴*P*)-4³-bromo-1,4(1,4)-dibenzencyclohexaphane-1²-carboxylic acid (PIN)
 (¹*S_p*,⁴*R_p*)-4³-bromo-1,4(1,4)-dibenzencyclohexaphane-1²-carboxylic acid

P-93.5.5.2 Specification of chirality centers

Example:

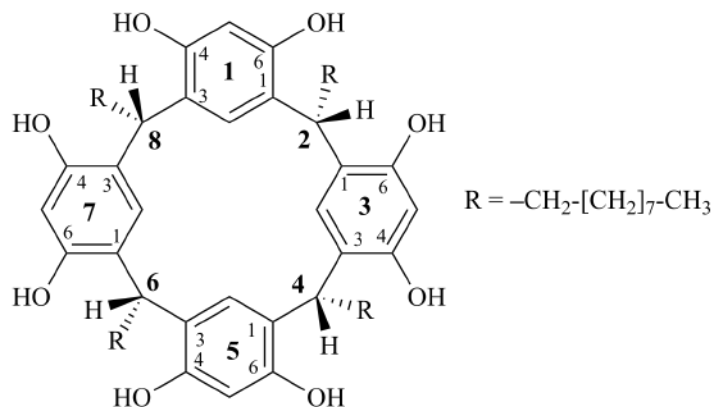

(*2r*,*4r*,*6r*,*8r*)-2,4,6,8-tetranonyl-1,3,5,7(1,3)-tetrabenzenacyclooctaphane-1⁴,1⁶,3⁴,3⁶,5⁴,5⁶,7⁴,7⁶-octol (PIN)
2r,*4c*,*6c*,*8c*-tetranonyl-1,3,5,7(1,3)-tetrabenzenacyclooctaphane-1⁴,1⁶,3⁴,3⁶,5⁴,5⁶,7⁴,7⁶-octol

P-93.5.5.3 Specification of double bonds

The omission of stereodescriptors '*E*' and '*Z*' to denote the configuration of double bonds in cyclophanes is related to the total number of nodes in the system; for up to seven nodes, no descriptor is necessary. When more than seven nodes are present, all descriptors of double bonds in rings of more than seven nodes are cited (see P-91.2.2).

Examples:

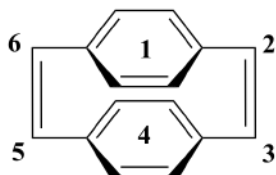

1,4(1,4)-dibenzenacyclohexaphane-2,5-diene (PIN)

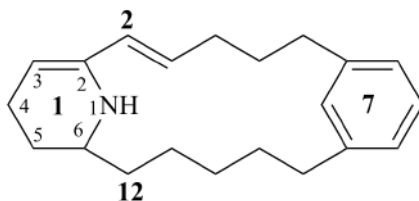

(2E)-1¹,1⁴,1⁵,1⁶-tetrahydro-1(2,6)-pyridina-7(1,3)-benzenacyclododecaphan-2-ene (PIN)

P-93.5.6 Fullerenes

P-93.5.6.1 Definitions and general methodology

Only general principles for describing stereochemical configuration of fullerenes are discussed briefly and exemplified in this section. Describing stereochemical configuration of fullerenes is extremely complex because of different factors such as the numbering of the fullerene molecule, systematic or trivial (in these recommendations, only the systematic numbering given in refs. 10, 11 is used), the nature and disposition of substituent groups on the fullerene, and the plurality of stereodescriptors necessary to describe their stereochemical configuration fully. For a full discussion of the description of fullerene configuration, one must go to the original publication (Section 17 in ref. 10).

For the purpose of describing stereochemical configuration, fullerenes and their derivatives are classified into four types depending on the origin of their chirality:

P-93.5.6.2 Type 1. Inherently chiral parent fullerenes;

P-93.5.6.3 Type 2. Substituted fullerenes inherently chiral because of their substitution pattern;

P-93.5.6.4 Type 3. Substituted fullerenes noninherently chiral because of their substitution pattern;

P-93.5.6.5 Type 4. Chirality due to chiral substituents;

P-93.5.6.6 Superimposition of stereogenic elements in a fullerene molecule

The four types are classified by the 'substitution test' that consists of changing the substituents in a single fullerene unit into a 'achiral test substituent', 'T', and verifying the chirality of the fullerene so modified by the presence of 'T' substituents (see Fig. 9.2)

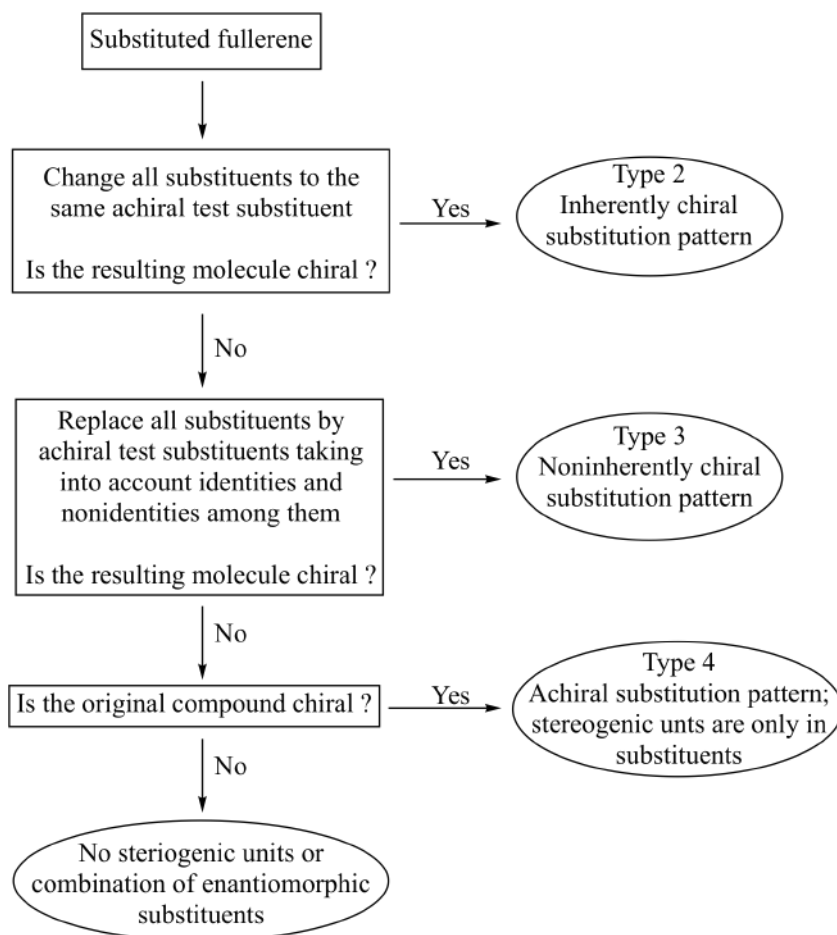
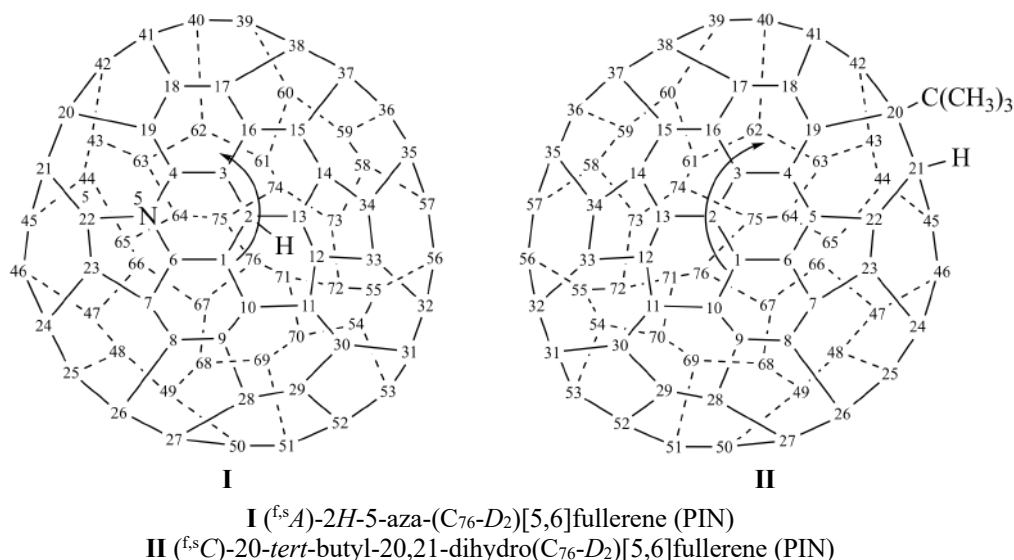

Fig. 9.2 Classification of fullerene chirality by a stepwise substitution pattern

P-93.5.6.2 Type 1. Inherently chiral parent fullerenes.

The two fullerene molecules described in Section P-27, $(C_{60}-I_h)[5,6]$ fullerene and the $(C_{70}-D_{5h(6)})[5,6]$ fullerene, are achiral; they are not inherently chiral. In contrast, the $(C_{76}-D_2)[5,6]$ fullerene shown below is inherently chiral. The numbering of an inherently chiral fullerene applies to a specific enantiomer; the other enantiomer has a numbering that is the mirror-image of the first numbering. A description of the handedness of the numbering scheme is sufficient to characterize the absolute configuration of the fullerene unambiguously. The viewer, looking at the polygon in which the numbering starts from outside the fullerene cage, traces a path from 'C-1' to 'C-2' to 'C-3', which is never aligned in a fullerene structure. If this path describes a clockwise direction, the configuration is indicated by the stereodescriptor $^f{}^x C$, where the superscript 'f' indicates that the descriptor refers to a fullerene, and the superscript 'x' is either 's' for the systematic numbering or 't' for the trivial numbering described in P-27.3. If the path from 'C-1' to 'C-2' to 'C-3' describes an anticlockwise direction, the descriptor is $^f{}^x A$. Thus, the fullerene on the right hand side below is described by the stereodescriptor $^f{}^s C$; its name is $(^f{}^s C)-(C_{76}-D_2)[5,6]$ fullerene. The fullerene on the left hand side is described by the stereodescriptor $^f{}^s A$; its name is $(^f{}^s A)-(C_{76}-D_2)[5,6]$ fullerene. The systematic numbering of these fullerenes is that used by Chemical Abstracts Service (ref. 22).

Examples:



P-93.5.6.3 Type 2. Substituted fullerenes inherently chiral because of their substitution pattern.

Derivatives of achiral (and chiral) parent fullerenes in which the presence of substituents, chiral or achiral, identical or different, on the fullerene skeleton creates a chiral substitution pattern are said to have an inherently chiral substitution pattern. Fullerene compounds of this type are all substituted achiral fullerenes. They have an inherently chiral substitution pattern if the existence of enantiomers is inherent to the geometrical arrangement of the substitution sites on the fullerene parent regardless of whether the substituents are identical or different. In these fullerene derivatives there is a unique numbering scheme that leads to the lowest set of locants for the substituents. As in P-93.5.6.2, the stereodescriptors are $^{f,x}C$ and $^{f,x}A$.

Example:

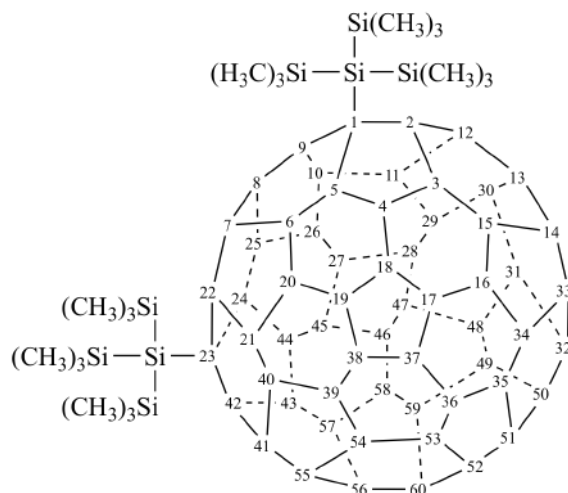

$^{f,s}C$ -1,23-bis[1,1,1,3,3,3-hexamethyl-2-(trimethylsilyl)trisilan-2-yl]-1,23-dihydro(C_{60} - I_h)[5,6]-fullerene (PIN)

Explanation: Locants for the substituents are '1,23' for clockwise numbering. But for anticlockwise numbering they are '1,29' and since '1,23' is lower than '1,29' according to the principle of lowest locants (see P-14.3.5) and therefore clockwise numbering is preferred. For the enantiomer, the lower locants '1,23' would be obtained on anticlockwise numbering and the descriptor would be $^{f,s}A$ -.

P-93.5.6.4 Type 3. Substituted fullerenes noninherently chiral because of their substitution pattern.

Derivatives of achiral parent fullerenes in which a chiral substitution pattern on the fullerene is due only to nonidentities among the substituents have a noninherently chiral substitution pattern.

The CIP system is used to rank substituents according to Sequence Rules 1 or 2 (see P-92.2 and P-92.3). In the following enantiomeric disubstituted fullerenes, the *tert*-butyl group has precedence over the 3,6-dicyclopropylcyclohepta-2,4,6-trien-1-yl group. Stereodescriptors $^{f,x}C$ and $^{f,x}A$ are used to describe the absolute configuration, as indicated in P-93.5.6.2, in conformity with whether the path C-1 to C-2 to C-3 is clockwise or anticlockwise.

Example:

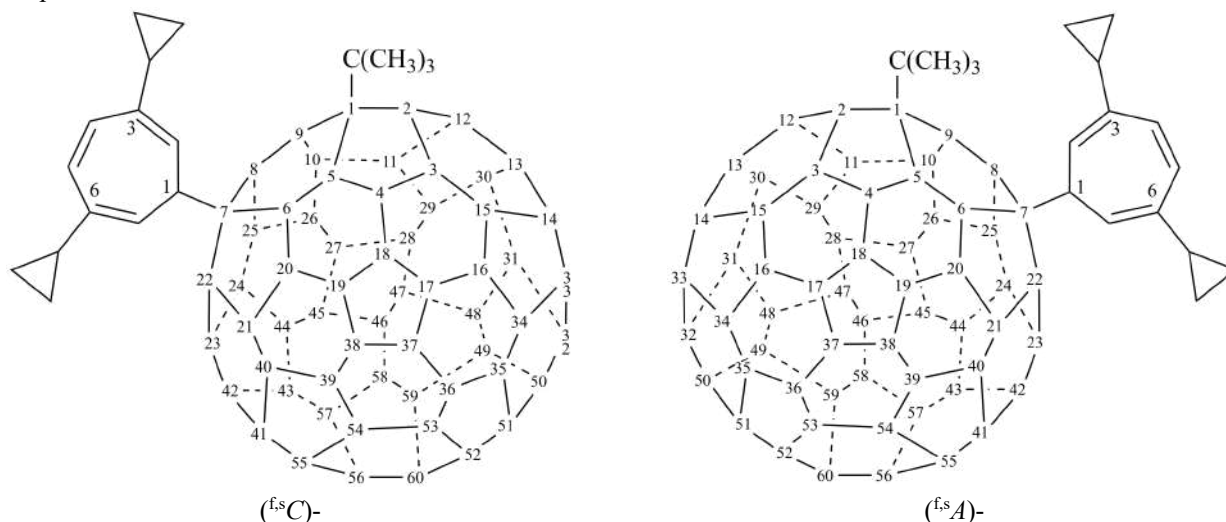

1-*tert*-butyl-7-(3,6-dicyclopropylcyclohepta-2,4,6-trien-1-yl)-1,7-dihydro(C_{60} - I_h)[5,6]fullerene (PIN)

Explanation: This compound is chiral only because the substituents are constitutionally different. The parent fullerene is achiral and it does not have an inherently chiral substitution pattern because replacement of both substituents by the same achiral test substituent, 'T', results in an achiral compound. Therefore it has a noninherently chiral substitution

pattern. The *tert*-butyl group is assigned the locant '1' because its CIP priority is higher than that of the 3,6-dicyclopropylcyclohepta-2,4,6-trien-1-yl group.

P-93.5.6.5 Type 4. Chirality due to chiral substituents.

Derivatives of achiral parent fullerenes in which the presence of chiral substituents does not create a chiral substitution pattern have the stereogenic units located exclusively in the substituents. In derivatives of this type, the chirality located in substituents is expressed by the usual CIP stereodescriptors. In the following example, the '*S*' configuration for the organyl group present in the -CO-O-R substituents is the only stereodescriptor needed to express the configuration of the compound.

Example:

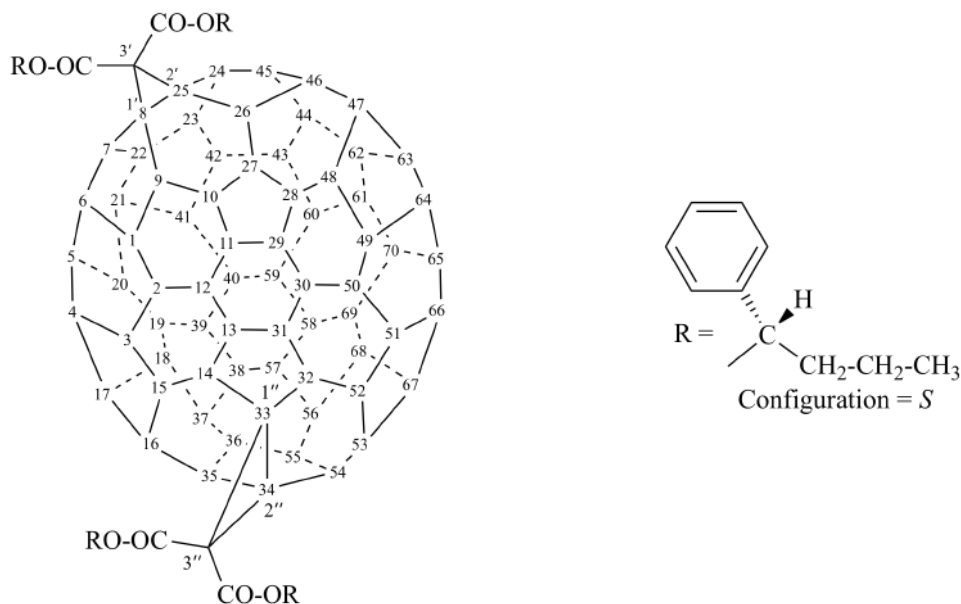

tetrakis[(1*S*)-1-phenylbutyl] 3'*H*,3''*H*-dicyclopropa[8,25:16,35](*C*₇₀-*D*_{5h(6)})[5,6]fullerene-3'*3'*,3''*3''*-tetracarboxylate (PIN)

Explanations:

(a) This fullerene derivative is chiral. The parent fullerene is achiral and the derivative has an achiral substitution pattern. The configuration of the substituents can be described by the normal descriptors of organic nomenclature (see P-91.3).

(b) If the esters of the acid in the above example were different, the parent fullerene and its substitution pattern would still be achiral and therefore any chirality of the original compound would be due to stereogenic centers located in the substituents.

P-93.5.6.6 Superimposition of stereogenic elements in a fullerene molecule.

If a fullerene derivative with an inherently or noninherently chiral substitution pattern carries chiral substituents, the configuration of both types of stereogenic elements has to be indicated. The two types are independent of each other and the configuration of both must be specified for a full description of the compound.

Example:

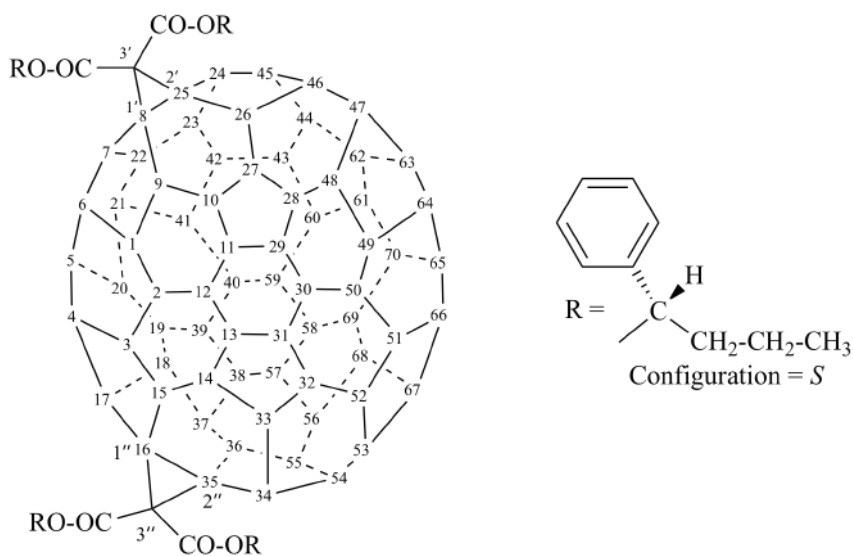

tetrakis[(1*S*)-1-phenylbutyl]
 (^{f,s}*C*)-3'*H*,3''*H*-dicyclopropa[8,25:33,34]-(*C*₇₀-*D*_{5h(6)})[5,6]fullerene-3'*3'*,3''*3''*,3'''-tetracarboxylate (PIN)

Explanation: The chiralities of the stereogenic centers in the esters are superimposed on the descriptor for the fullerene with the inherently chiral substitution pattern. The enantiomer would be named:

tetrakis[(1*R*)-1-phenylbutyl] (^{f,s}*A*)-3'*H*,3''*H*-dicyclopropa[8,25:33,34]-(*C*₇₀-*D*_{5h(6)})[5,6]fullerene-3'*3'*,3''*3''*,3'''-tetracarboxylate (PIN)

and similarly for the various diastereoisomers.

P-93.5.7 Ring assemblies

P-93.5.7.1 Specification of stereogenic axes

P-93.5.7.2 Specification of stereogenic centers

P-93.5.7.3 Specification of double bonds in unsaturated alicyclic rings assemblies

P-93.5.7.1 Specification of stereogenic axes

The descriptors '*M*' and '*P*' are preferred to '*R_a*' and '*S_a*', respectively, to denote the stereogenic axis, in accordance with the methodology described in P-92.1.2.2.1 and P-92.1.2.1.2.

Examples:

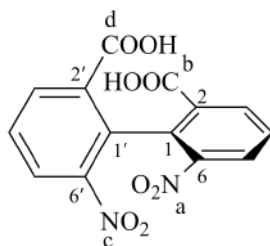

(1*M*)-6,6'-dinitro[1,1'-biphenyl]-2,2'-dicarboxylic acid (PIN)
 (1*R_a*)-6,6'-dinitro[1,1'-biphenyl]-2,2'-dicarboxylic acid

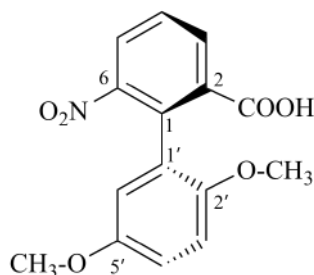

(1*P*)-2',5'-dimethoxy-6-nitro[1,1'-biphenyl]-2-carboxylic acid (PIN)
 (1*S_a*)-2',5'-dimethoxy-6-nitro[1,1'-biphenyl]-2-carboxylic acid

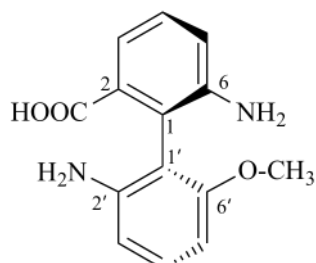

(1*M*)-2',6-diamino-6'-methoxy[1,1'-biphenyl]-2-carboxylic acid (PIN)
 (1*R_a*)-2',6-diamino-6'-methoxy[1,1'-biphenyl]-2-carboxylic acid

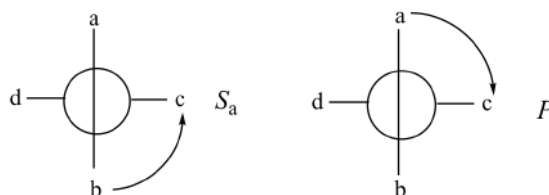
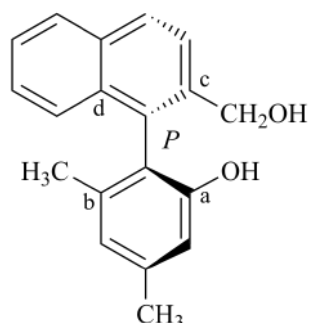

(2*P*)-2-[2-(hydroxymethyl)naphthalen-1-yl]-3,5-dimethylphenol (PIN)
 (2*S_a*)-2-[2-(hydroxymethyl)naphthalen-1-yl]-3,5-dimethylphenol

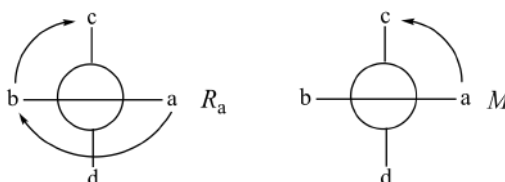
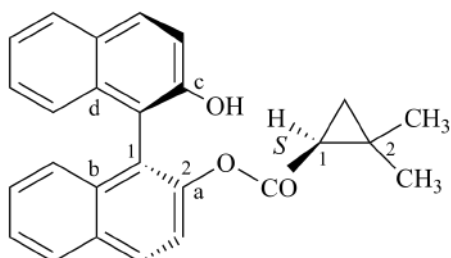

(1*M*)-2'-hydroxy[1,1'-binaphthalen]-2-yl (1*S*)-2,2-dimethylcyclopropane-1-carboxylate (PIN)
 (1*R_a*)-2'-hydroxy[1,1'-binaphthalen]-2-yl (1*S*)-2,2-dimethylcyclopropane-1-carboxylate

P-93.5.7.2 Specification of stereogenic centers

In preferred IUPAC names, stereogenic centers are specified by stereodescriptors such as '*R*', '*S*', '*r*', and '*s*'. In general nomenclature, the stereodescriptors '*cis*' and '*trans*' may be used as described in P-93.5.1.2.

Examples:

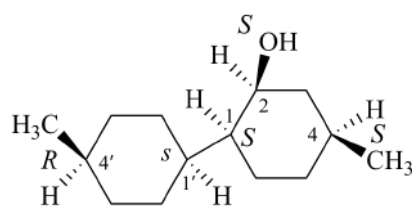

(1*S*,1'*s*,2*S*,4*S*,4'*R*)-4,4'-dimethyl[1,1'-bi(cyclohexan)]-2-ol (PIN)

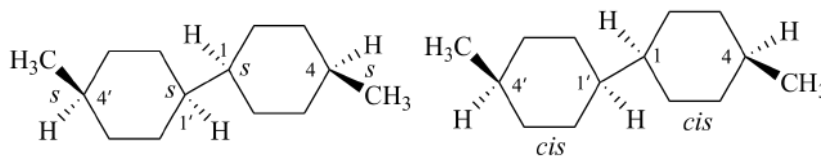

(a) (1*s*,1'*s*,4*s*,4'*s*)-4,4'-dimethyl-1,1'-bi(cyclohexane) (PIN)
 (b) [1(4)-*cis*,1'(4')-*cis*]-4,4'-dimethyl-1,1'-bi(cyclohexane)

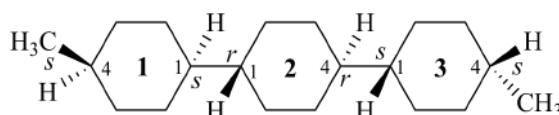

(1'*s*,1⁴*s*,2¹*r*,2⁴*r*,3¹*s*,3⁴*s*)-1⁴,3⁴-dimethyl-1¹,2¹:2⁴,3¹-tercyclohexane (PIN)
 [1¹(1⁴)-*cis*,2¹(2⁴)-*trans*,3¹(3⁴)-*cis*]-1⁴,3⁴-dimethyl-1¹,2¹:2⁴,3¹-tercyclohexane

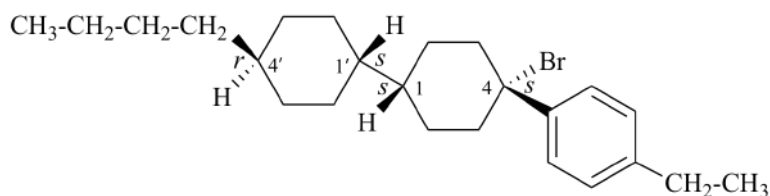

(1^{1s},1^{4r},2^{1s},2^{4s})-2⁴-bromo-1⁴-butyl-3⁴-ethyl-1¹,1²,1³,1⁴,1⁵,1⁶,2¹,2²,2³,2⁴,2⁵,2⁶-dodecahydro-1¹,2¹:2⁴,3¹-terphenyl (PIN)
 (1^s,1^{'s},4^s,4^{'r})-4-bromo-4'-butyl-4-(4-ethylphenyl)-1,1'-bi(cyclohexane) [numbering shown]
 (1^s,1^{'s},4^r,4^{'s})-4'-bromo-4-butyl-4''-ethyl-1,1',2,2',3,3',4,4',5,5',6,6'-dodecahydro-1,1':4',1''-terphenyl

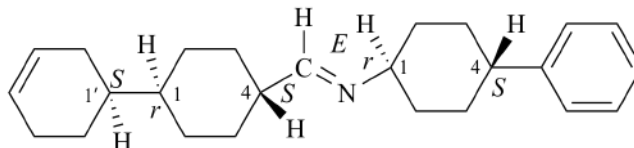

(1*E*)-1-[(1*r*,1'^S,4*S*)-[1,1'-bi(cyclohexan)]-3'-en-4-yl]-*N*-[(1*r*,4*S*)-4-phenylcyclohexyl]methanimine (PIN)
 (*E*)-1-[1(4)-*trans*-(1'^S)-[1,1'-bi(cyclohexan)]-3'-en-4-yl]-*N-trans*-4-phenylcyclohexyl)methanimine

P-93.5.7.3 Specification of double bonds in unsaturated alicyclic ring assemblies

The general methodology described in P-91.2.2 is applied to unsaturated alicyclic ring assemblies. In eight-membered rings, all stereogenic units must be specified, when one needs to be specified.

Examples:

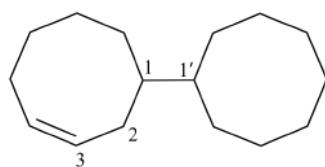

(3*Z*)-[1,1'-bi(cyclooctan)]-3-ene (PIN)

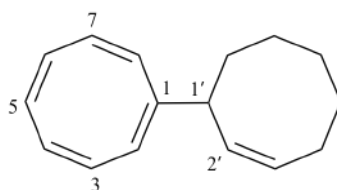

(1*Z*,2'^Z,3*Z*,5*Z*,7*Z*)-[1,1'-bi(cyclooctane)]-1,2',3,5,7-pentaene (PIN)

P-93.6 COMPOUNDS COMPOSED OF RINGS AND CHAINS

In the construction of names of organic compounds, the first step is to form the name according to the principles, rules, and conventions described in Chapters P-1 through P-8; in a second step, stereodescriptors are added, in accordance with rules expressed in Chapter P-9. This addition of stereodescriptors does not change a preferred IUPAC name, be it a substitutive name, a phane name, or a functional class name, and the corresponding names formed by skeletal ('a') replacement nomenclature, provided that stereodescriptors are added in conformity with numbering. Care must be taken in dealing with multiplicative names which must be formed in accordance with the symmetry requirements, including stereodescriptors, essential to this type of nomenclature for being accepted as preferred IUPAC names.

Example 1:

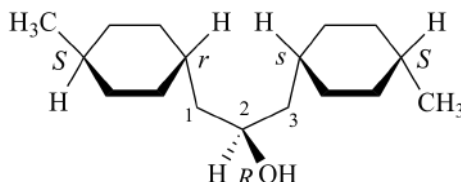

(2*R*)-1-[(1*r*,4*S*)-4-methylcyclohexyl]-3-[(1*s*,4*S*)-4-methylcyclohexyl]propan-2-ol (PIN)
 (2*R*)-1-(*cis*-4-methylcyclohexyl)-3-(*trans*-4-methylcyclohexyl)propan-2-ol

Explanation:

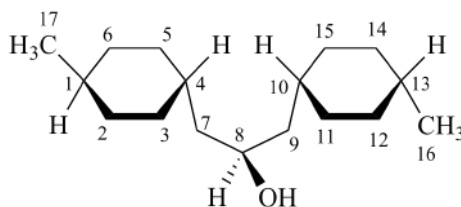

arbitrary numbering for the simplified digraphs

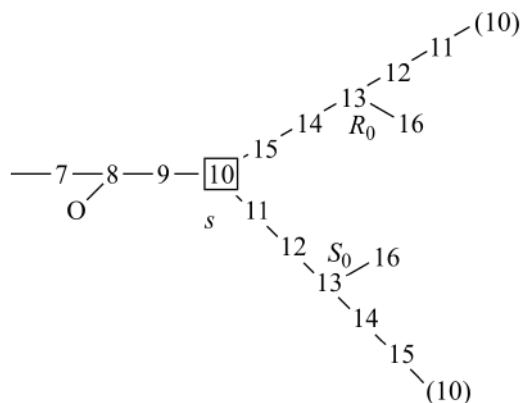
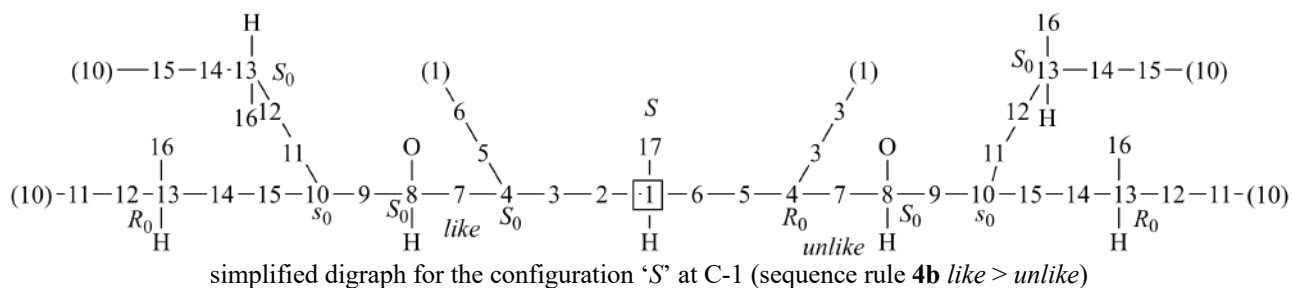

The configuration 'R' at 'C-8' is determined by applying Sequence Rule 4c, 'r' precedes 's'.

Example 2:

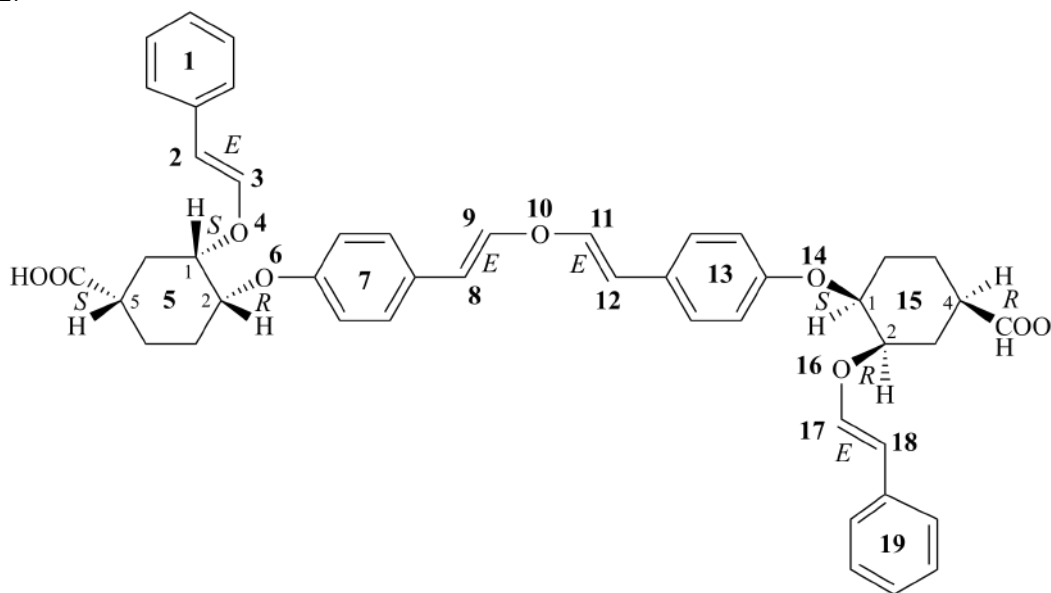

(2E,5¹S,5²R,5⁵S,8E,11E,15¹S,15²R,15⁴R,17E)-4,6,10,14,16-pentaoxa-1,19(1),7,13(1,4)-tetrabenzena-5,15(1,2)-dicyclohexanonadecaphane-2,8,11,17-tetraene-5⁵,15⁴-dicarboxylic acid (PIN: a phane name)

Example 3:

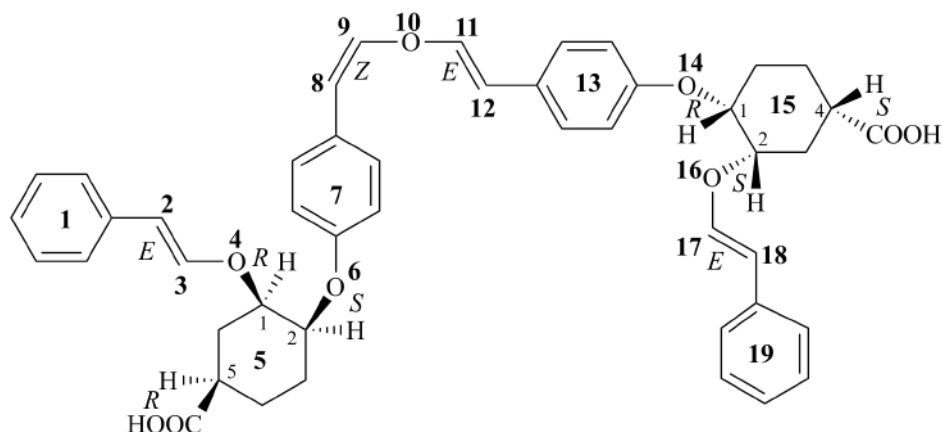

(2E,5¹R,5²S,5⁵R,8Z,11E,15¹R,15²S,15⁴S,17E)-4,6,10,14,16-pentaoxa-1,19(1),7,13(1,4)-tetrabenzena-5,15(1,2)-dicyclohexanonadecaphane-2,8,11,17-tetraene-5⁵,15⁴-dicarboxylic acid (PIN: a phane name)

Example 4:

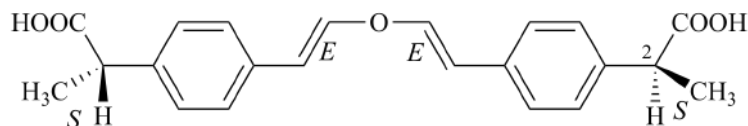

(2*S*,2'*S*)-2,2'-{oxybis[(*E*)-ethene-2,1-diyl-4,1-phenylene]}dipropanoic acid (PIN)
(a multiplicative name is the preferred IUPAC name, the symmetry requirements for its use being fulfilled)

Example 5:

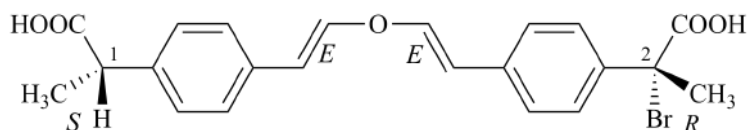

(2*R*)-2-bromo-2-{4-[(*E*)-2-{(*E*)-2-{4-[(1*S*)-1-carboxyethyl]phenyl}ethen-1-yl]oxy}ethen-1-yl]phenyl}propanoic acid (PIN; a multiplicative name is not allowed, because of the different stereodescriptors and nonidentical repeated parent structures)

Example 6:

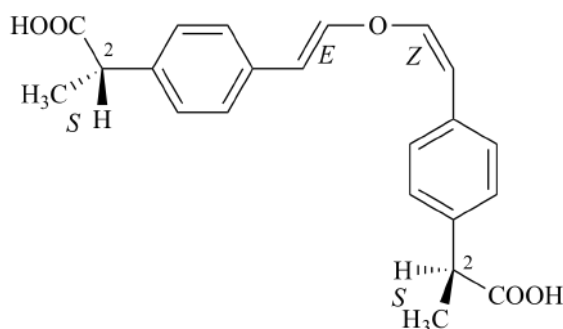

(2*S*)-2-{4-[(*E*)-2-{(Z)-2-{4-[(1*S*)-1-carboxyethyl]phenyl}ethen-1-yl]oxy}ethen-1-yl]phenyl}propanoic acid (PIN; a multiplicative name is not allowed, because of the lack of identical components in the central substituent group)

P-94 CONFORMATION AND CONFORMATIONAL STEREODESCRIPTORS

This Section is based on the IUPAC publication “Basic Terminology of Stereochemistry” (see ref. 37).

P-94.1 DEFINITION

A conformation is the spatial arrangement of the atoms affording distinction between stereoisomers which can be interconverted by rotations about formally single bonds, as exemplified for conformers A and B in Fig. 9.3.

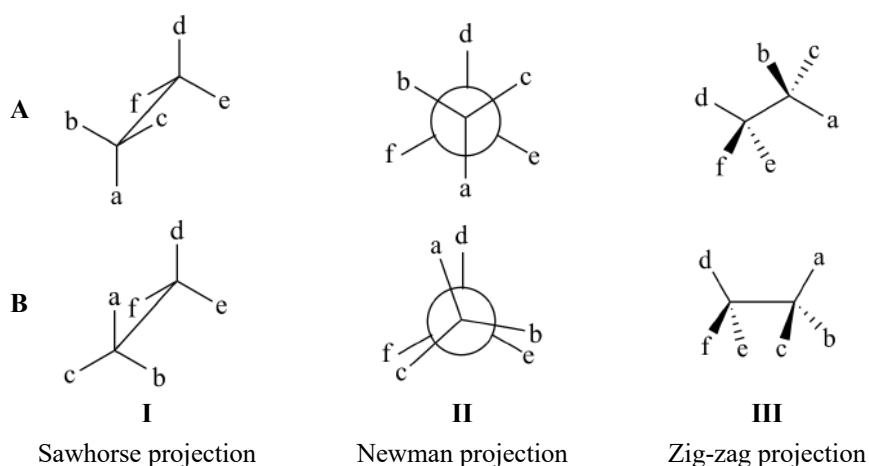

Fig. 9.3. Three different representations of two conformers A and B.

P-94.2 TORSION ANGLE

P-94.2.1 In an assembly of attached atoms X-A-B-Y, where neither X nor Y is collinear with A and B, the smaller angle subtended by the bonds X-A and Y-B in a plane projection obtained by viewing the assembly along the axis A-B is termed the ‘torsion angle’, denoted by the italicized lower-case Greek letter θ . The torsion angle is considered positive or negative according as the bond atom X or Y requires rotation to the right (clockwise) or left (anticlockwise), respectively, in order that its direction may coincide with that of the bond to the rear selected atom Y or X. The

multiplicity of the bonding of the various atoms is irrelevant. A torsion angle also exists if the axis for rotation is formed by a collinear set of more than two atoms directly attached to each other.

Conformations are described as synperiplanar (*sp*), synclinal (*sc*), anticlinal (*ac*), or antiperiplanar (*ap*), according as the torsion angle is within $\pm 30^\circ$ of 0° ; $\pm 60^\circ$, $\pm 120^\circ$, or $\pm 180^\circ$, respectively; the letters in parentheses are the corresponding abbreviations.

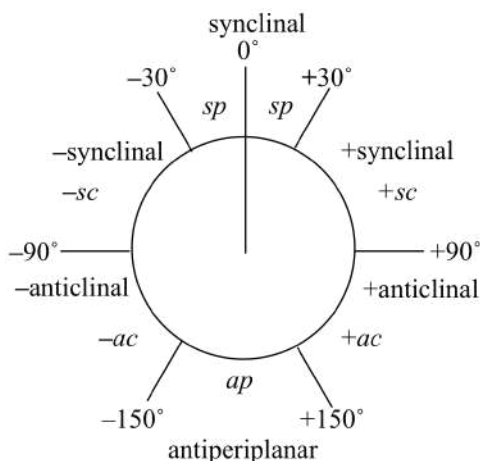

To choose the appropriate stereodescriptor, atoms or groups are selected from each set to define the torsion angle according to the following criteria:

- (1) if all the atoms or groups of a set are different, that one of each set that has priority by the sequence rule;
- (2) if one of a set is unique, that one;
- (3) if all of a set are identical, that one which provides the smallest torsion angle.

Examples:

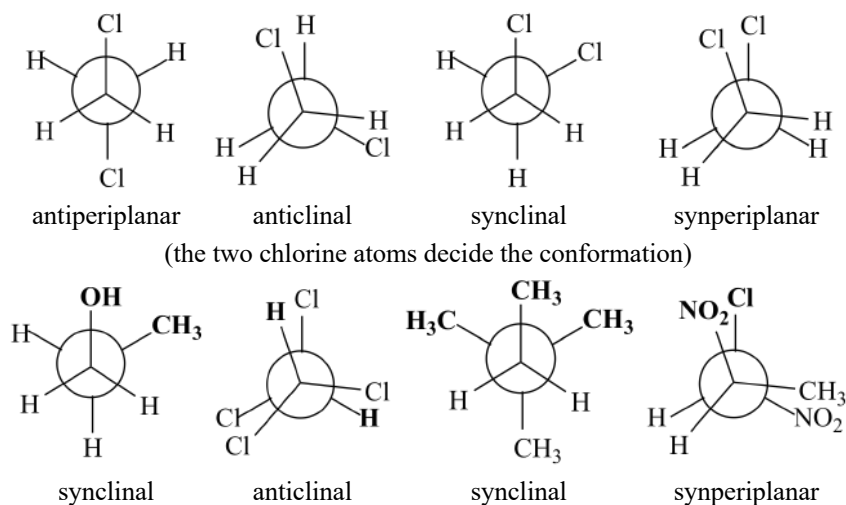

Criteria from above for:

the rear atom

2 2 3 1

the front atom

2 2 2 1

P-94.2.2 If 'A' and 'B' in 'X-A-B-Y' are trigonal centers, a lone pair of electrons represented by two dots is taken into consideration to decide the description of the conformation, as illustrated by the example below describing the conformation of 1,1-dimethylhydrazine, $(\text{CH}_3)_2\text{N-NH}_2$; the lone pairs of electrons are the phantom atoms of the sequence rules symbolism. Similarly, trigonal centers involving double bonds are analyzed with the sequence rules by using duplicate atoms to determine the order of precedence.

Examples:

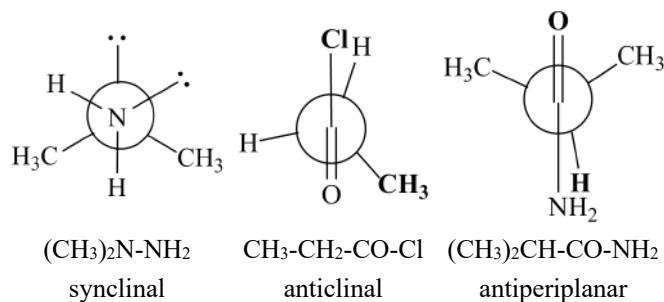

Criteria from above for:

the rear atom	2	2	2
the front atom	2	1	1

P-94.3 SPECIFIC STEREODESCRIPTORS

Stereodescriptors are used to denote specific conformers, both aliphatic and alicyclic.

P-94.3.1 Eclipsed, staggered and gauche (or skew) conformations

P-94.3.1.1 Two atoms or groups attached to two adjacent atoms are said to be ‘eclipsed’ if the torsion angle between them is zero. They are said to be ‘staggered’ when they are as far apart as possible from an eclipsed conformation. ‘Gauche’ or ‘skew’ are synonymous with synclinal, which is preferred. The stereodescriptors ‘*trans*’ or ‘*anti*’ are not recommended in place of ‘anticlinal’, nor ‘*cis*’ or ‘*syn*’ in place of ‘synclinal’. Eclipsed and staggered are stereodescriptors used to denote the conformations when all ligands are identical.

Examples:

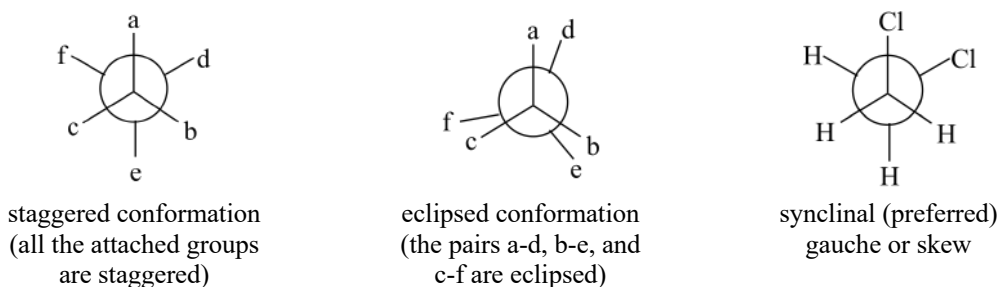

P-94.3.1.2 For a structure containing the grouping $\text{R}_3\text{C}-\text{C}(\text{Y})=\text{X}$ (with identical or different R groups) the conformation in which the torsion angle is such that X is antiperiplanar to one of the R group, and, in a Newman projection, the double bond bisects one of the R-C-R angles, is called a ‘bisecting conformation’. The other conformation, in which X is synperiplanar to one of the R group, is called an ‘eclipsing conformation’.

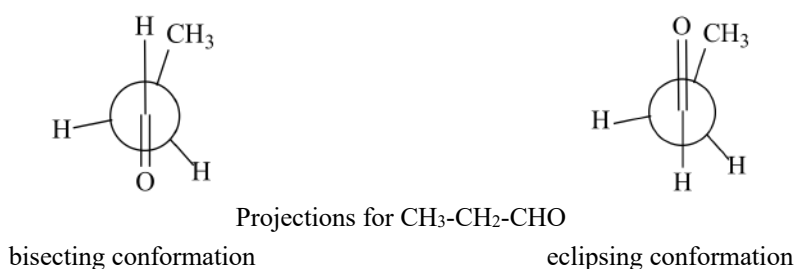

P-94.3.1.3 Stereodescriptors *s-cis* and *s-trans*

The spatial arrangement of two conjugated double bonds about the intervening single bond is described as ‘*s-cis*’ if ‘synperiplanar’ and ‘*s-trans*’ if ‘antiperiplanar’. This descriptor should not be applied to other systems such as *N*-alkyl amides (use ‘*E/Z*’ or ‘*sp/ap*’).

Examples:

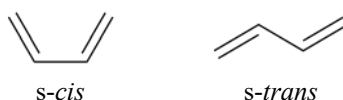

P-94.3.2 Stereodescriptors for denoting the conformations of alicyclic rings

P-94.3.2.1 Envelope conformation

The envelope conformation is the conformation of a five-membered ring in which four atoms are coplanar and one atom projects out of the plane.

Example:



P-94.3.2.2 Chair, boat, and twist conformations

When carbon atoms 1, 2, 4, and 5 of a six-membered ring occupy coplanar positions and when carbon atoms 3 and 6 are on opposite sides of the plane the conformation is called a chair form. It is a boat form when carbon atoms 3 and 6 are on the same side of the plane. The conformation passed through in the interconversion of two boat forms of six-membered ring is called the twist form; this term is preferred to skew boat, skew form, or stretched form.

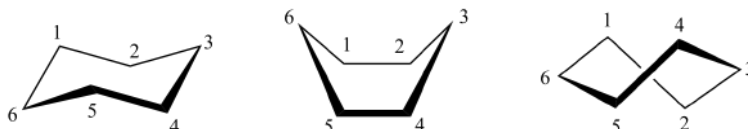

In carbohydrate stereochemistry, the term twist refers to a five-membered ring and the twist conformation is referred to as skew.

P-94.3.2.3 Half-chair

A molecule of a monounsaturated six-membered ring is described as being in a 'half-chair' conformation according as the atoms not directly linked to the double bond lie on opposite sides of the plane.

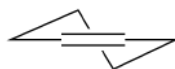

P-94.3.2.4 Crown conformation

The conformation of a saturated cyclic molecular entity, containing an even number (≥ 8) of atoms in the ring, in which these atoms lie alternately in each of two parallel planes and are symmetrically equivalent (D_{4d} for cyclooctane, D_{5d} for cyclodecane, etc.), is called a 'crown conformation'.



cyclooctane

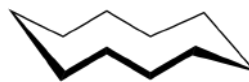

cyclodecane

P-94.3.2.5 Tub conformation

The conformation of an eight-membered ring in which the four atoms forming one pair of diametrically opposite bonds in the ring lie in one plane and all other ring atoms lie on one side of that plane is called a 'tub conformation'.



P-94.3.2.6 In-out isomerism

In-out isomerism is found in bicyclic systems having bridges long enough to allow the bridgehead exocyclic bond or lone pair of electrons to point either inside the structure or outside.

Example 1:

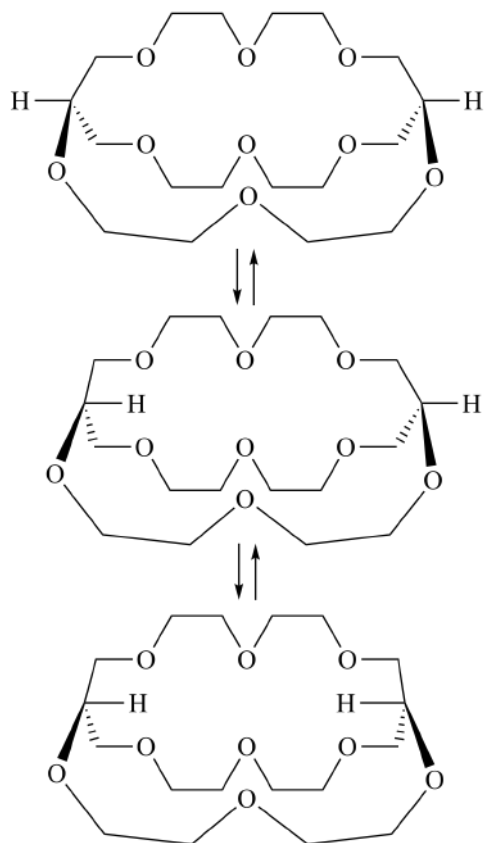

Example 2:

